

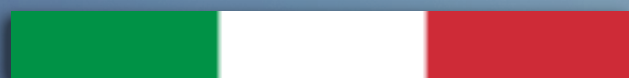

CATALOGO

2026



Made in Italy

Presentazione

INTRODUZIONE

Assotherm è un'affermata realtà Italiana introdotta nel settore della produzione di componentistica per impianti idrotermosanitari, climatizzazione e ventilazione. Grazie alla quindicennale esperienza maturata nel settore, garantisce l'approvvigionamento di prodotti specifici destinati al settore, derivanti dal ciclo di produzione di metalli ferrosi e non ferrosi come: Acciaio al carbonio, Ghisa Malleabile, Acciaio inossidabile, Ottone e Rame.

L'azienda, fondata nel 2007, è oggi leader di mercato nella distribuzione dei Sistemi di tipo Press Fittings, componenti inventati per garantire una corretta distribuzione dei fluidi negli impianti idrotermosanitari e di altra specie, con una sorprendente facilità di messa in opera e con enorme risparmio nei tempi di installazione. Il tutto offerto tenendo la massima attenzione al rapporto Qualità/Prezzo.

La specializzazione e la competenza di Assotherm, si delineano poi nel settore della componentistica tradizionale in ottone, sviluppando famiglie di prodotto come valvole a sfera, raccorderie tradizionali a filettatura o a saldatura, valvolame per radiatore, accessori e componenti per centrale termica e per la distribuzione dei circuiti come i collettori di distribuzione.

Completano la gamma dei prodotti, la vasta varietà di prodotti per il settore industriale e per la gestione delle reti idriche, come Valvolame a farfalla, Filtri d'impurità, Saracinesche di intercettazione e molto altro.

Tra i sistemi completi, oltre al Core Business dei Sistemi a pressare, Assotherm è specializzata nella progettazione e distribuzione di Sistemi radianti di Climatizzazione invernale ed estiva integrati alla costante necessità del recupero del calore per il risparmio energetico e del ricambio d'aria degli ambienti che permettono all'utente di vivere in un ambiente totalmente pulito e sano da impurità e batteri.

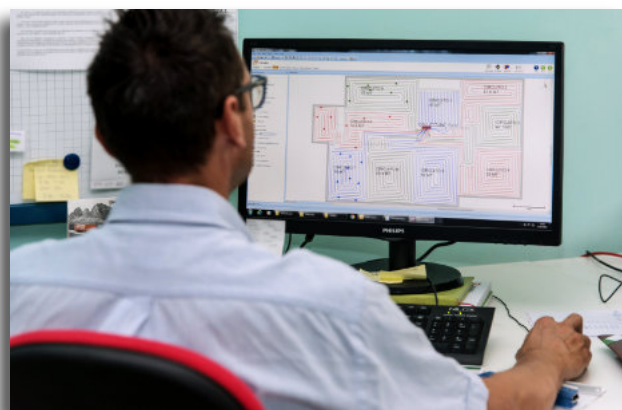



INTRODUCTION

Assotherm is an established Italian company introduced in the field of production of components for plumbing, heating, air conditioning and ventilation systems. Thanks to the fifteen-year experience gained in the sector, guarantees the supply of specific products for the sector, deriving from the production cycle of ferrous and non-ferrous metals such as: carbon steel, malleable iron, stainless steel, brass and copper.

The company founded in 2007, is now the market leader in the distribution of Press Fittings type systems, components invented to ensure a correct distribution of fluids in plumbing systems and other species, with a surprising ease of implementation and with huge savings in installation time. All offered with the utmost attention to the price-quality ratio.

Assotherm's specialization and expertise are then outlined in the field of traditional brass components, developing product families such as ball valves, traditional threaded or welded fittings, radiator valves, accessories and components for thermal power plant and for the distribution of circuits such as the distribution manifolds.

To complete the product range it offers the wide variety of products for the industrial sector and for the management of water networks, such as butterfly valves, impurity filters, gate gates and much more.

Among the complete systems, in addition to the Core Business of Press Systems, Assotherm is specialized in the design and distribution of winter and summer Radiant Air Conditioning Systems, integrated to the constant need of heat recovery for energy saving and the air exchange of the environments that allow the user to live in a healthy environment, totally clean and from impurities and bacteria.





SERVIZI

Sin dalla sua fondazione, Assotherm ha dedicato il massimo sforzo al costante monitoraggio del servizio offerto alla clientela per favorire processi di economia nel rapporto e per permettere la massima flessibilità e fluidità nella gestione degli ordini e nella valorizzazione del prodotto.

In prima istanza Assotherm offre un servizio di studio e di personalizzazione del prodotto che può passare dalla realizzazione a marchio del cliente, al confezionamento secondo l'esigenza del cliente e alla logistica degli imballi con la gestione della codificazione a barre.

Un aspetto di grande vantaggio è rappresentato dai meeting periodici che vengono svolti con gli installatori che permettono di valutare tutti i vantaggi e le eventuali criticità dei prodotti al fine di consentire un costante miglioramento qualitativo.

SERVICES

Since its inception, Assotherm has dedicated the maximum effort to the constant monitoring of the offered service to the customers to support economies of scale in the relationship and in order to allow the maximum flexibility and fluidity in the orders management and products valorisation.

Assotherm offers a service of study and customization of the product that can pass from the realization to the customer's brand, to the packaging according to the customer's need and to the packaging logistics with the management of the bar coding.

An aspect of great advantage is represented by the periodic meetings that are carried out with the installers that allow to evaluate all the advantages and possible criticalities of the products in order to allow a constant improvement in quality.



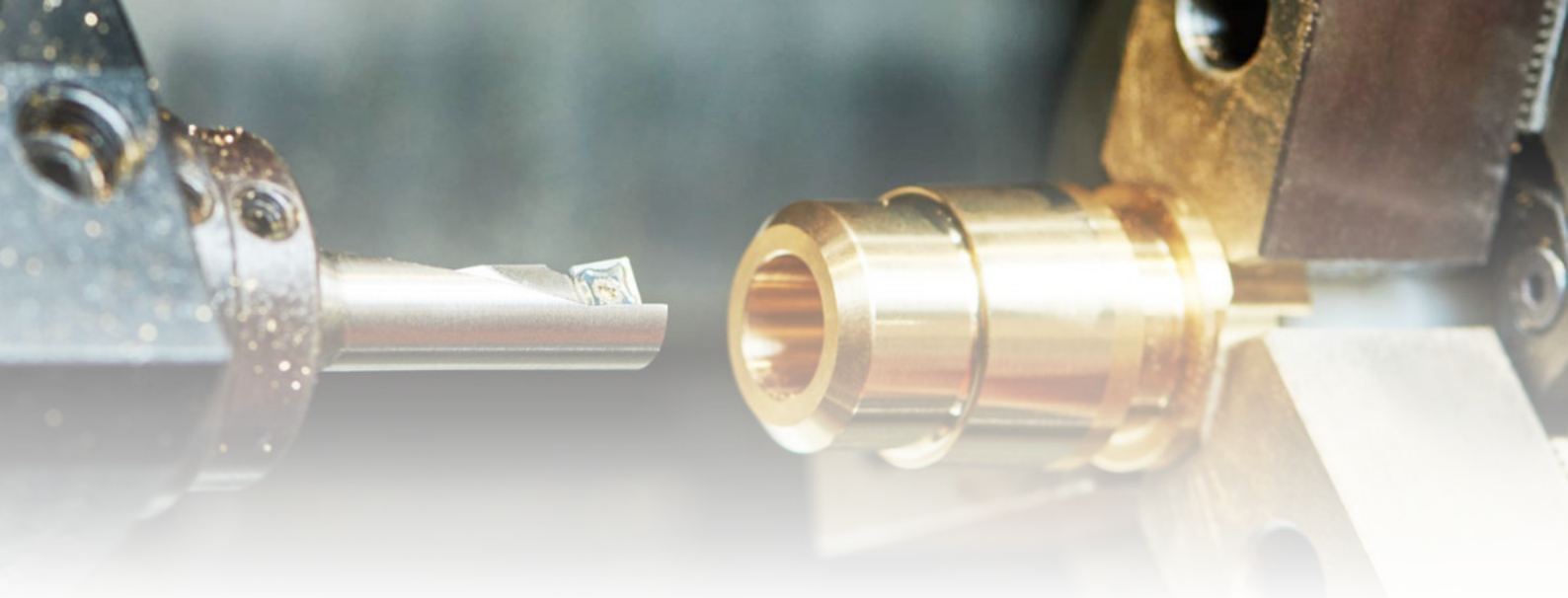

STRUTTURA

Assotherm si colloca come interlocutore primario nel mercato interno attraverso una rete di Agenti di commercio regionali e laddove non presenti attraverso il proprio Ufficio Commerciale Italia.

Il 45% del proprio volume di affari è all'export per il tramite di importatori grossisti che operando da intermediari permettono ad Assotherm di distribuire i propri prodotti in più di 20 Paesi in Europa ed extra CE.

La struttura di Assotherm si avvale di un organico medio attorno alle 40 persone ed opera sotto un sistema di Qualità garantito dalla norma ISO:9001.

Assotherm svolge la propria attività in due diversi impianti su un'area di circa 4.000 metri quadrati.

STRUCTURE

Assotherm is the primary interlocutor in the internal market through a network of regional Sales Agents and where not present through its Sales Office Italy.

45% of its turnover is exported through importers and wholesalers who operate as intermediaries and allow Assotherm to distribute its products in more than 20 countries in Europe and outside the EC.

The Assotherm facility employs an average staff of around 40 people and operates under a quality system guaranteed by the ISO:9001 standard.

Assotherm carries out its activity in two different plants on an area of about 4,000 square meters.

DOVE SIAMO / WHERE WE ARE



www.assotherm.it

Assotherm

Servizi associati per la termoidraulica



QUALITÀ CERTIFICATA
PER UN' ACQUA PIÙ PURA



Sommario

■ Riscaldamento e Valvolame

- 8. Riscaldamento radiante / Heating floor systems
- 19. Ventilazione Meccanica Controllata / Controlled Mechanical Ventilation
- 22. Valvole termosifone / Radiator Valves
- 26. Valvole fancoil / fancoil Valves
- 29. Accessori per termosifoni / Accessories for panel radiators
- 32. Riduttori di pressione / Preassure reducing valves
- 35. Prodotti complementari acqua / Various water products
- 42. Strumenti di misurazione e intercettazione / Measuring components
- 47. Elettrovalvole e filtri gas / Solenoid valves and Gaz filters
- 51. Filtri magnetici multifunzione / Multifunction magnetic dirt separators
- 54. Valvole a sfera / Ball valves
- 65. Valvole miscelatrici e deviatrici / Mixing valves
- 67. Valvole con attuatore / Motor valves
- 69. Valvole industriali / Industrial valves
- 77. Staffaggi / Anchors and fixings
- 81. Collettori sanitaria e riscaldamento / Sanitary and heating manifolds
- 84. Adattatori vari / various adapters
- 87. Kit preassemblati / Pre-assembled kits

■ Press Fitting Systems

- 92. Raccordi a pressare per tubo multistrato / Press fittings for multilayer pipe
- 97. Raccordi a stringere per tubo multistrato / Compression fittings for multilayer pipe
- 100. Raccordi a pressare in acciaio al carbonio / Carbon steel press fittings
- 106. Raccordi a pressare in acciaio INOX AISI 316L / Stainless steel AISI 316L press fittings
- 113. Raccordi a pressare in acciaio INOX AISI 304L / Stainless steel AISI 304L press fittings
- 120. Raccordi a pressare in rame / Copper press fittings
- 124. Tubazioni per sistemi a pressare / Press pipes

■ Raccorderia

- 128. Raccordi filettati in ghisa zincata / Malleable iron fittings
- 140. Raccordi filettati ottone / Brass threaded fittings
- 147. Raccordi filettati INOX / Stainless steel threaded fittings
- 154. Raccordi a stringere per tubo polietilene / Compression fittings for polyethylene pipe
- 158. Raccordi a stringere per tubo rame / Compression fittings for copper pipe
- 162. Raccordi a saldare in acciaio al carbonio / Steel soldering fittings
- 165. Raccordi a saldare INOX / Stainless steel soldering fittings
- 168. Tubazioni per sistemi a saldare e filettare / Soldering and threading pipes
- 169. Raccorderia generica ottone / Generic brass fittings
- 171. Accessori per raccorderia / Fittings accessories

PRODOTTI PER RISCALDAMENTO E RAFFRESCAMENTO RADIANTE

Classic



Fast



Flat



Compact



Agi-comfort[®]



Agi-comfort è un marchio registrato
prodotto e distribuito da Assotherm.

Visita il sito per tutte le informazioni
tecniche sui sistemi Agi-comfort.

www.agicomfort.it

**Prodotti per riscaldamento radiante****radiant heating products****CPS 856X**

Collettore INOX + flussimetri e valvole termostattizzabili / Stainless steel manifold with flow meter and thermostable valves

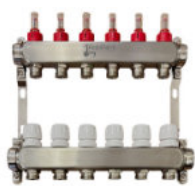

Cod.	Size			€ / Cad.
CPS856X10703T	1" x 3/4"	3 vie / 3 ways	1	87,04
CPS856X10704T	1" x 3/4"	4 vie / 4 ways	1	107,84
CPS856X10705T	1" x 3/4"	5 vie / 5 ways	1	131,76
CPS856X10706T	1" x 3/4"	6 vie / 6 ways	1	159,84
CPS856X10707T	1" x 3/4"	7 vie / 7 ways	1	181,68
CPS856X10708T	1" x 3/4"	8 vie / 8 ways	1	207,68
CPS856X10709T	1" x 3/4"	9 vie / 9 ways	1	228,48
CPS856X10710T	1" x 3/4"	10 vie / 10 ways	1	251,36
CPS856X10711T	1" x 3/4"	11 vie / 11 ways	1	273,20
CPS856X10712T	1" x 3/4"	12 vie / 12 ways	1	294,00
CPS856X10713T	1" x 3/4"	13 vie / 13 ways	1	329,00

CPS 856S

Collettore INOX + kit carico/sfiato, flussimetri e valvole termostabilizzabili / Stainless steel manifold + fill/vent kit, flow meters and thermostabilisable valves

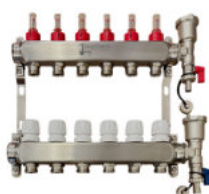

Cod.	Size			€ / Cad.
CPS856S10703T	1" x 3/4"	3 vie / 3 ways	1	115,02
CPS856S10704T	1" x 3/4"	4 vie / 4 ways	1	135,42
CPS856S10705T	1" x 3/4"	5 vie / 5 ways	1	158,88
CPS856S10706T	1" x 3/4"	6 vie / 6 ways	1	186,42
CPS856S10707T	1" x 3/4"	7 vie / 7 ways	1	207,84
CPS856S10708T	1" x 3/4"	8 vie / 8 ways	1	233,34
CPS856S10709T	1" x 3/4"	9 vie / 9 ways	1	253,74
CPS856S10710T	1" x 3/4"	10 vie / 10 ways	1	276,18
CPS856S10711T	1" x 3/4"	11 vie / 11 ways	1	297,60
CPS856S10712T	1" x 3/4"	12 vie / 12 ways	1	318,00
CPS856S10713T	1" x 3/4"	13 vie / 13 ways	1	350,00

CPS 856V

Collettore INOX + kit carico/sfiato, valvole a sfera con termometri, flussimetri e valvole termostattizzabili / Stainless steel manifold + fill/vent kit, ball valves with thermometers, flow meters and thermostatic valves

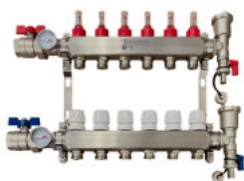

Cod.	Size			€ / Cad.
CPS856V10703T	1" x 3/4"	3 vie / 3 ways	1	151,00
CPS856V10704T	1" x 3/4"	4 vie / 4 ways	1	171,00
CPS856V10705T	1" x 3/4"	5 vie / 5 ways	1	194,00
CPS856V10706T	1" x 3/4"	6 vie / 6 ways	1	221,00
CPS856V10707T	1" x 3/4"	7 vie / 7 ways	1	242,00
CPS856V10708T	1" x 3/4"	8 vie / 8 ways	1	267,00
CPS856V10709T	1" x 3/4"	9 vie / 9 ways	1	287,00
CPS856V10710T	1" x 3/4"	10 vie / 10 ways	1	309,00
CPS856V10711T	1" x 3/4"	11 vie / 11 ways	1	330,00
CPS856V10712T	1" x 3/4"	12 vie / 12 ways	1	350,00
CPS856V10713T	1" x 3/4"	13 vie / 13 ways	1	371,00

COIB856

Coppia guscio isolante per collettori CPS856 (raffrescamento) / Couple insulating shell for chilled manifolds CPS856



Cod.	Size			€ / Cad.
COIB856	13 Vie tagliabile / 13 Ways cuttable		1	33,88

clicca il seguente link: www.assotherm.it o scannerizza il QR-Code per scaricare le schede tecniche dei prodotti



CPS 855

Collettore in polimero con termometro, kit carico-sfiato, valvole a sfera, flussimetri e valvole termostattizzabili / Polymer manifold with thermometer, fill-vent kit, ball valves, flow meters and thermostatic valves

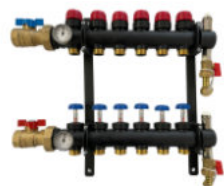

Cod.	Size			€ / Cad.
CPS8550100703	1" x 3/4"	3 vie / 3 ways	1	197,27
CPS8550100704	1" x 3/4"	4 vie / 4 ways	1	216,06
CPS8550100705	1" x 3/4"	5 vie / 5 ways	1	231,72
CPS8550100706	1" x 3/4"	6 vie / 6 ways	1	247,37
CPS8550100707	1" x 3/4"	7 vie / 7 ways	1	275,56
CPS8550100708	1" x 3/4"	8 vie / 8 ways	1	291,21
CPS8550100709	1" x 3/4"	9 vie / 9 ways	1	310,00
CPS8550100710	1" x 3/4"	10 vie / 10 ways	1	335,05
CPS8550100711	1" x 3/4"	11 vie / 11 ways	1	360,10
CPS8550100712	1" x 3/4"	12 vie / 12 ways	1	385,15
CPS8550100713	1" x 3/4"	13 vie / 13 ways	1	407,07

CPS 853

Collettore in polimero a doppia camera con termometro, kit carico-sfiato, flussimetri e valvole termostattizzabili / Double chamber polymer manifold with thermometer, fill-vent kit, flow meters and thermostatic valves

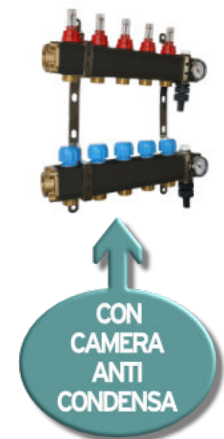

Cod.	Size			€ / Cad.
CPS8530100703	1" x 3/4"	3 vie / 3 ways	1	215,00
CPS8530100704	1" x 3/4"	4 vie / 4 ways	1	253,00
CPS8530100705	1" x 3/4"	5 vie / 5 ways	1	292,00
CPS8530100706	1" x 3/4"	6 vie / 6 ways	1	330,00
CPS8530100707	1" x 3/4"	7 vie / 7 ways	1	373,00
CPS8530100708	1" x 3/4"	8 vie / 8 ways	1	414,00
CPS8530100709	1" x 3/4"	9 vie / 9 ways	1	452,00
CPS8530100710	1" x 3/4"	10 vie / 10 ways	1	490,00
CPS8530100711	1" x 3/4"	11 vie / 11 ways	1	532,00
CPS8530100712	1" x 3/4"	12 vie / 12 ways	1	572,00

CPS 854

Collettore in polimero con termometro, kit carico/sfiato, flussimetri e valvole termostattizzabili / Polymer manifold with thermometer, fill/vent kit, flow meters and thermostatic valves



Cod.	Size			€ / Cad.
CPS8540120702	1" 1/4 x 3/4"	2vie / 2 ways	1	168,01
CPS8540120703	1" 1/4 x 3/4"	3 vie / 3 ways	1	207,04
CPS8540120704	1" 1/4 x 3/4"	4 vie / 4 ways	1	251,17
CPS8540120705	1" 1/4 x 3/4"	5 vie / 5 ways	1	291,90
CPS8540120706	1" 1/4 x 3/4"	6 vie / 6 ways	1	329,52
CPS8540120707	1" 1/4 x 3/4"	7 vie / 7 ways	1	375,34
CPS8540120708	1" 1/4 x 3/4"	8 vie / 8 ways	1	418,61
CPS8540120709	1" 1/4 x 3/4"	9 vie / 9 ways	1	461,32
CPS8540120710	1" 1/4 x 3/4"	10 vie / 10 ways	1	508,84
CPS8540120711	1" 1/4 x 3/4"	11 vie / 11 ways	1	547,02

clicca il seguente link: www.assotherm.it o scannerizza il QR-Code per scaricare le schede tecniche dei prodotti



CPS 0096

Kit 2 pezzi valvole di carico/sfiato andata e ritorno / Kit of 2 drain valves with automatic air discharge



Cod.	Size		€ / Cad.
CPS00960110V	1"	1	31,00

CPS 0096B

Gruppo di carico/sfiato singolo BLU / Single drain off valve with automatic air discharge BLUE



Cod.	Size		€ / Cad.
CPS00960110VB	1"	1	17,00

CPS 0096R

Gruppo di carico/sfiato singolo ROSSA / Single drain off valve with automatic air discharge RED



Cod.	Size		€ / Cad.
CPS00960110VR	1"	1	17,00

CPS 0095B

Kit di carico e sfiato aria manuale BLU / Single drain off valve with manual air discharge BLUE



Cod.	Size		€ / Cad.
CPS00950110B	1"	1	15,60

CPS 0095R

Kit di carico e sfiato aria manuale ROSSA / Single drain off valve with manual air discharge RED



Cod.	Size		€ / Cad.
CPS00950110R	1"	1	15,60

clicca il seguente link: www.assotherm.it o scannerizza il QR-Code per scaricare le schede tecniche dei prodotti



VS 146BT

Kit 2 valvole a sfera bocchettonate dritte con termometro, andata e ritorno /Kit of 2 straight union ball valves with thermometer, flow and return



Cod.	Size		€ / Cad.
VS0146BT010PRNT	1"	1	39,00

VS 146BT B

Valvola a sfera bocchettonata con termometro BLU / Union ball valve with thermometer BLUE



Cod.	Size		€ / Cad.
VS0146BT010PRNTB	1"	1	20,00

VS 146BT R

Valvola a sfera bocchettonata con termometro ROSSA / Union ball valve straight pattern with thermometer RED



Cod.	Size		€ / Cad.
VS0146BT010PRNTR	1"	1	20,00

VS 146AT

Kit 2 valvole a sfera bocchettonate a squadra con termometro, andata e ritorno / Kit of 2 angle pattern union ball valves with thermometer, flow and return



Cod.	Size		€ / Cad.
VS0146AT010PRNT	1"	1	49,00

VS 146AT B

Valvola a sfera a squadra bocchettonata con termometro BLU /Union ball valve with thermometer BLUE



Cod.	Size		€ / Cad.
VS0146AT010PRNTB	1"	1	25,30

VS 146AT R

Valvola a sfera a squadra bocchettonata con termometro ROSSA /Union ball valve with thermometer RED



Cod.	Size		€ / Cad.
VS0146AT010PRNTR	1"	1	25,30

clicca il seguente link: www.assotherm.it o scannerizza il QR-Code per scaricare le schede tecniche dei prodotti



DC 83P

Adattatore eurocono per tubo PEX / PEX pipe adapter eurokonus



Cod.	Size		€ / Cad.
DC0083P007165	3/4" x 16 x 1,5	10	3,40
DC0083P00716	3/4" x 16 x 2	10	3,40
DC0083P00717	3/4" x 17 x 2	10	3,40
DC0083P00720	3/4" x 20 x 2	10	4,90

DC 83M

Adattatore eurocono per tubo multistrato / Multilayer pipe adapter eurokonus



Cod.	Size		€ / Cad.
DC0083M00716	3/4" x 16 x 2	10	3,40
DC0083M00720	3/4" x 20 x 2	10	3,90

CLI 507

Testa termostatica quattro fili per collettori / Four-wire thermostatic head for manifolds



Cod.	Size		€ / Cad.
CLI507000230	230 V	1	40,00
CLI507000240	24 V	1	40,00

CLI 508

Testa termostatica due fili per collettori / Two-wire thermostatic head for manifolds



Cod.	Size		€ / Cad.
CLI508000230	230 V	1	35,00
CLI508000240	24 V	1	35,00

CS 35

Cassetta in lamiera per collettori / Iron box for manifolds



Cod.	Size		€ / Cad.
CS00350000400	Fino a 3 vie / Up to 3 ways	10	100,00
CS00350000600	Fino a 7 vie / Up to 7 ways	10	121,00
CS00350000800	Fino a 11 vie / Up to 11 ways	10	152,00
CS00350001000	Fino a 13 vie / Up to 13 ways	10	190,00

clicca il seguente link: www.assotherm.it o scannerizza il QR-Code per scaricare le schede tecniche dei prodotti





Sistema classic



Classic system

AGIROLL

Pannello in doghe di poliestere espanso sinterizzato EPS 150 / Insulating roll-panel in EPS 150

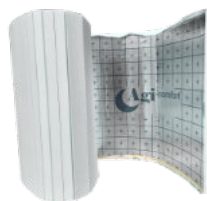

Cod.	Size		€ / Cad.
AGIROLL00020	23 mm	10 m	18,60
AGIROLL00030	30 mm	10 m	21,50

TUBOMULTI

Tubo multistrato / Multilayer pipe



Cod.	Size		€ / Cad.
TUBOMULT0016	16 x 2	100 m	
TUBOMULTD016	16 x 2	250 m	
TUBOMULTC016	16 x 2	500 m	

→ Prezzi netti periodici / Periodic net prices



Sistema Fast



Fast system

AGIFELT

Pannello in doghe di poliestere espanso sinterizzato EPS 150 con grafite, sistema "velcro" / Insulating roll-panel in EPS 150, "felt" system



Cod.	Size		€ / Cad.
AGIFELT00023	23 mm	10 m	15,63
AGIFELT00030	30 mm	10 m	17,23

TUBOFELT

Tubo PE-RT sistema "velcro" / PE-RT pipe "felt" system



In rotolo / In roll

Cod.	Size		€ / Cad.
TUBOFELT0016	16 x 2	500 m	

→ Prezzi netti periodici / Periodic net prices

clicca il seguente link: www.assotherm.it o scannerizza il QR-Code per scaricare le schede tecniche dei prodotti



AGIPLAN

Pannello bugnato in polistirene espanso EPS 150 / Insulating knobbed panel in EPS 150

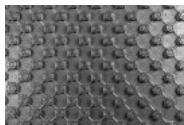

Cod.	Size		€ / Cad.
AGIPLAN00030	10 + 22 mm	22	13,50
AGIPLAN00040	20 + 22 mm	16	15,40
AGIPLAN00050	30 + 22 mm	12	18,00

TUBOPEXA

Tubo PEX-A / PEX-A Pipe



Cod.	Size		€ / Cad.
TUBOPEXA17300	17 x 2	300 m	
TUBOPEXA17600	17 x 2	600 m	

→ **Prezzi netti periodici / Periodic net prices****AGISLIM**

Pannello bugnato in polistirene espanso EPS a basso spessore / Insulating knobbed panel in low thickness EPS expanded polystyrene



Cod.	Size	EPS		€ / Cad.
AGISLIM00005	5 + 18 mm	300	12	18,47
AGISLIM00010	10 + 18 mm	200	24	19,30

**TUBOPEXA**

Tubo PEX-A / PEX-A Pipe



Cod.	Size		€ / Cad.
TUBOPEXA17300	17 x 2	300 m	
TUBOPEXA17600	17 x 2	600 m	

→ **Prezzi netti periodici / Periodic net prices**clicca il seguente link: www.assotherm.it o scannerizza il QR-Code
per scaricare le schede tecniche dei prodotti

Dry-Air

Deumidificatore per sistemi di raffreddamento radiante / Dehumidifier for radiant cooling systems



Cod.	Size		€ / Cad.
DRYAIR000300	300 m ³ /h	1	

→ Prezzi netti a richiesta / Net prices on demand

GIUNTO

Giunto di dilatazione termica / Expansion joint



Cod.	Size		€ / m
GIUNTO002000	2000 mm	1	12,00

RETE METALLICA

Rete metallica antiritiro 50 x 50 mm / Non-shrink wire mesh 50 x 50 mm

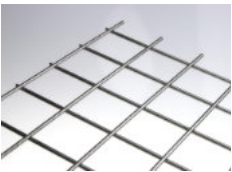

Cod.	Size		€ / Cad.
RETE00000	1 m x 2 m	40	

→ Prezzi netti a richiesta / Net prices on demand

BENDA

Benda perimetrale / Perimeter tape



Cod.	Size		€ / m
BENDAPER0015	150 mm x 60 m	40	2,48

FLUID

Additivo per massetto / Additive for concrete



Cod.	Size		€ / Kg
FLUIDMAS010	10 Kg	1	9,00

clicca il seguente link: www.assotherm.it o scannerizza il QR-Code
per scaricare le schede tecniche dei prodotti



CLIPS

Clip di fissaggio tubo / Fixing clips



Cod.	Size		€ / Cad.
CLIPS0001620	16 - 17 - 20	1000	0,16

REGGICURVA

Curva di sostegno / Support curve



Cod.	Size		€ / Cad.
REGGICURVA16	16 - 18	50	1,75
REGGICURVA20	20 - 22	10	2,20

CPS 651

By-pass primario con stacco alta temperatura / Primary by-pass with high temperature cut-out



Cod.	Size		€ / Cad.
CPS651000010	1"	1	100,00

CPS 654

Flussimetro / Flowmeter



Cod.	Size			€ / Cad.
CPS654000070	3/4"	0 - 5 L/min	1	20,80

SROTO

Srotolatore / Unroller



Cod.	Size			€ / Cad.
SROTO00000000			1	650,00

GRAF

Graffettatrice per clips / Stapler for clips



Cod.	Size			€ / Cad.
GRAF00000000			1	622,00

clicca il seguente link: www.assotherm.it o scannerizza il QR-Code per scaricare le schede tecniche dei prodotti





Regolazione a punto fisso



Fixed point adjustment

CPS 650

Gruppo di regolazione a punto fisso / Fixed point mixing unit



Cod.	Size		€ / Cad.
CPS65000010	1"	1	620,00



Regolazione climatica



Climate regulation

CENTRALINA

Centralina di regolazione sistema radiante / Radiant system regulation control unit



Cod.	Size	Tipo sonda di temperatura mandata		€ / Cad.
CENTR_CONTATTO	230 V	a contatto	1	611,98
CENTR_IMMERSIONE	230 V	ad immersione	1	660,39

SONDA ESTERNA

Sonda temperatura esterna / External temperature probe



Cod.		€ / Cad.
SONDA_TEMP_EST	1	91,17

SONDA INTERNA

Sonda temperatura e umidità relativa / Temperature and relative humidity probe



Cod.		€ / Cad.
SONDA_TEMP_UM	1	577,53

VZ 158

Valvola miscelatrice 3 vie, bocchettonata / 3 way mixing valve, nut and tail



Cod.	Size		€ / Cad.
VZ0158000005	1/2"	1	77,81
VZ0158000007	3/4"	1	97,71
VZ0158000010	1"	1	137,37

VZ 216

Servocomando 3 punti modulante per valvola VZ 158 / Servo control 3 modulating points for valve VZ 158



Cod.	Size		€ / Cad.
VZ0216000024	24 V	1	155,92
VZ0216000230	230 V	1	149,98

clicca il seguente link: www.assotherm.it o scannerizza il QR-Code per scaricare le schede tecniche dei prodotti



VENTILAZIONE MECCANICA CONTROLLATA

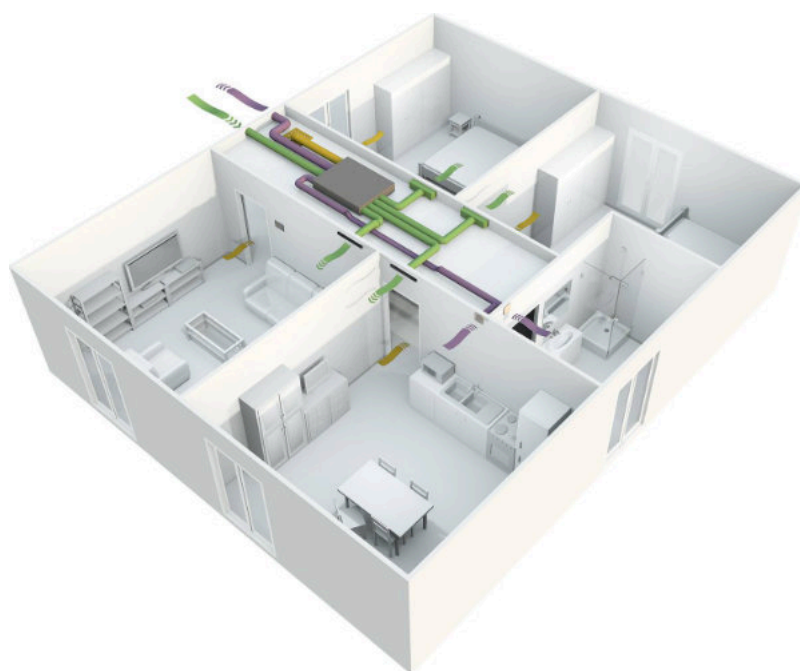

Agi-comfort è un marchio registrato
prodotto e distribuito da Assotherm.

Visita il sito per tutte le informazioni
tecniche sui sistemi Agi-comfort.

www.agicomfort.it



→ Prezzi netti a richiesta / Net prices on demand

Quick-Air

Sistema di ventilazione puntuale con recuperatore di calore / Punctual ventilation system with heat recovery



Cod.	Size	Comando	
VMCQUICKE024	24 m ³ /h	Elettronico	1
VMCQUICKE050	50 m ³ /h	Elettronico	1

Cosmo-Air

Sistema di ventilazione a doppio flusso con recuperatore di calore / Double flow ventilation system with heat recovery



Cod.	Size	
VMCCOSM00115	115 m ³ /h	1

Nova-Mini

Sistema di ventilazione a doppio flusso con recuperatore di calore / Double flow ventilation system with heat recovery



Cod.	Size	
VMCNOVAM0267	267 m ³ /h	1

Nova-V

Sistema di ventilazione a doppio flusso con recuperatore di calore / Double flow ventilation system with heat recovery



Cod.	Size	
VMCNOVAV0149	149 m ³ /h	1
VMCNOVAV0279	279 m ³ /h	1

Nova-H

Sistema di ventilazione a doppio flusso con recuperatore di calore / Double flow ventilation system with heat recovery



Cod.	Size	
VMCNOVAH0218	218 m ³ /h	1

clicca il seguente link: www.assotherm.it o scannerizza il QR-Code per scaricare le schede tecniche dei prodotti





Ventilazione Meccanica Controllata con deumidifica



Controlled Mechanical Ventilation with dehumidification

→ Prezzi netti a richiesta / Net prices on demand

Sunny-Air

Sistema di ventilazione e deumidifica a doppio flusso con recuperatore di calore / Double flow ventilation and dehumidification system with heat recovery



Cod.	Size	Deumidifica	
VMCSUN3015F	300 - 150 m ³ /h	Frigor (compressore)	1
VMCSUN3015I	300 - 150 m ³ /h	Idronico (acqua 7/12 °C)	1
VMCSUN5025F	500 - 250 m ³ /h	Frigor (compressore)	1
VMCSUN5025I	500 - 250 m ³ /h	Idronico (acqua 7/12 °C)	1

Sunny-Air V

Sistema di ventilazione e deumidifica a doppio flusso con recuperatore di calore / Double flow ventilation and dehumidification system with heat recovery



Cod.	Size	Deumidifica	
VMCSUNV3015F	300 - 150 m ³ /h	Frigor (compressore)	1
VMCSUNV3015I	300 - 150 m ³ /h	Idronico (acqua 7/12 °C)	1
VMCSUNV5025F	500 - 250m ³ /h	Frigor (compressore)	1
VMCSUNV5025I	500 - 250m ³ /h	Idronico (acqua 7/12 °C)	1



Ventilazione Meccanica Controllata Terziario e industria



Controlled Mechanical Ventilation Tertiary and industry

→ Prezzi netti a richiesta / Net prices on demand

Wind-H

Sistema di ventilazione a doppio flusso con recuperatore di calore / Double flow ventilation system with heat recovery



Cod.	Size	
VMCWINDH0397	397 m ³ /h	1
VMCWINDH0810	810 m ³ /h	1
VMCWINDH1740	1740 m ³ /h	1
VMCWINDH2400	2400 m ³ /h	1
VMCWINDH3840	3840 m ³ /h	1
VMCWINDH5800	5800 m ³ /h	1

Wind-V

Sistema di ventilazione a doppio flusso con recuperatore di calore / Double flow ventilation system with heat recovery



Cod.	Size	
VMCWINDV0397	397 m ³ /h	1
VMCWINDV0810	810 m ³ /h	1
VMCWINDV1740	1740 m ³ /h	1

clicca il seguente link: www.assotherm.it o scannerizza il QR-Code per scaricare le schede tecniche dei prodotti



VALVOLE PER TERMOSIFONE



Le valvole per termosifone o radiatore sono necessariamente indicate per la perfetta regolazione ed intercettazione del fluido all'interno del radiatore. Grazie alle valvole e ai detentori, si permette all'acqua del circuito di riscaldamento di rimanere nel termosifone per il tempo necessario a garantire il fabbisogno termico dell'ambiente.

Si dividono a comando manuale o termostattizzabili per mezzo di una testina che apre o chiude la valvola a seconda della temperatura impostata.



The valves for heater or radiator are essential for the perfect regulation and interception of the fluid inside the radiator. Thanks to valves and to lockshields, the water of the heating circuit remains in the radiator for the time necessary to ensure the thermal demand of the environment.

They are divided into manual or thermostat control by means of a head that opens or closes the valve depending on the set temperature.

**TH 105R**

Valvola a squadra termostattabile per tubo rame e multistrato / Angle valve with thermostatic option for multilayer and copper pipe



Cod.	Size		€ / Cad.
TH0105R0300N	3/8"	10	9,50
TH0105R0500N	1/2"	10	10,90

TH 106R

Valvola diritta termostattabile per tubo rame e multistrato / Straight valve with thermostatic option for multilayer and copper pipe



Cod.	Size		€ / Cad.
TH0106R0300N	3/8"	10	9,50
TH0106R0500N	1/2"	10	10,90

VT 117R

Detentore a squadra per tubo rame e multistrato / Angle lockshield for multilayer and copper pipe



Cod.	Size		€ / Cad.
VT0117R0300N	3/8"	10	6,07
VT0117R0500N	1/2"	10	6,56

VT 118R

Detentore dritto per tubo rame e multistrato / Straight lockshield for multilayer and copper pipe



Cod.	Size		€ / Cad.
VT0118R0300N	3/8"	10	6,29
VT0118R0500N	1/2"	10	6,90

TH 105

Valvola a squadra termostattabile per tubo ferro / Angle valve with thermostatic option for iron pipe



Cod.	Size		€ / Cad.
TH010500300N	3/8"	10	10,50
TH010500500N	1/2"	10	11,50

clicca il seguente link: www.assotherm.it o scannerizza il QR-Code per scaricare le schede tecniche dei prodotti



TH 106

Valvola diritta termostattizzabile per tubo ferro / Straight valve with thermostatic option for iron pipe



Cod.	Size		€ / Cad.
TH010600300N	3/8"	10	11,00
TH010600500N	1/2"	10	12,00

VT 117

Detentore a squadra per tubo ferro / Angle lockshield for iron pipe



Cod.	Size		€ / Cad.
VT011700300N	3/8"	10	6,40
VT011700500N	1/2"	10	7,00
VT011700700N	3/4"	10	13,40

VT 118

Detentore dritto per tubo ferro / Straight lockshield for iron pipe



Cod.	Size		€ / Cad.
VT011800300N	3/8"	10	6,50
VT011800500N	1/2"	10	7,10
VT011800700N	3/4"	10	13,90

VT 119R

Valvola a squadra manuale per tubo rame e multistrato / Manual angle valve for multilayer and copper pipe



Cod.	Size		€ / Cad.
VT0119R0300N	3/8"	10	7,00
VT0119R0500N	1/2"	10	7,90

VT 120R

Valvola dritta manuale per tubo rame multistrato / Manual straight valve for multilayer and copper pipe



Cod.	Size		€ / Cad.
VT0120R0300N	3/8"	10	7,50
VT0120R0500N	1/2"	10	8,40

clicca il seguente link: www.assotherm.it o scannerizza il QR-Code per scaricare le schede tecniche dei prodotti



VT 119

Valvola a squadra manuale per tubo ferro / Manual angle valve for iron pipe



Cod.	Size		€ / Cad.
VT011900300N	3/8"	10	7,00
VT011900500N	1/2"	10	7,90
VT011900700N	3/4"	10	15,55

VT 120

Valvola dritta manuale per tubo ferro / Straight manual valve for iron pipe



Cod.	Size		€ / Cad.
VT012000300N	3/8"	10	7,50
VT012000500N	1/2"	10	8,40
VT012000700N	3/4"	10	15,55

MT 90

Valvola doppia dritta, tenuta piatta / Double straight valve



Cod.	Size		€ / Cad.
MT009000700N	3/4"	10	15,44

MT 91

Valvola doppia a squadra, tenuta piatta / Double angle valve



Cod.	Size		€ / Cad.
MT009100700N	3/4"	10	16,48

TH 108L

Testa termostatica con sensore a liquido / Thermostatic head with liquid sensor



Cod.		€ / Cad.
TH0108L00000	10	16,80

VOL3

Volantino micrometrico per valvola termostatica / Micrometric regulator for thermostatic valve



Cod.		€ / Cad.
VOL03000000	10	3,69

clicca il seguente link: www.assotherm.it o scannerizza il QR-Code per scaricare le schede tecniche dei prodotti



VALVOLE PER FANCOIL



Le valvole per fancoil sono necessariamente indicate per la perfetta regolazione ed intercettazione del fluido all'interno del fancoil. Grazie a queste valvole, si permette all'acqua del circuito di riscaldamento e raffreddamento di rimanere nel fancoil per il tempo necessario a garantire il fabbisogno termico dell'ambiente.

Per mezzo di un attuatore elettrotermico che apre o chiude la valvola, si ottengono i valori della temperatura impostata.



Fancoil valves are necessarily indicated for the perfect regulation and interception of the fluid inside the fancoil. Thanks to these valves, the water of the heating and cooling circuit is allowed to remain in the fancoil for the time necessary to ensure the thermal demand of the environment.

By means of an electric actuator that opens or closes the valve, the values of the set temperature are obtained.

MT 222

Valvola 2 vie per fan coil / 2-ways valve for fan coil



Cod.	Size		€ / Cad.
MT022200500N	1/2"	10	18,20
MT022200700N	3/4"	10	20,28
MT022201000N	1"	10	24,96

MT 223

Valvola 3 vie per fan coil / 3-ways valve for fan coil



Cod.	Size		€ / Cad.
MT022300500N	1/2"	10	30,77
MT022300700N	3/4"	10	31,14
MT022301000N	1"	10	34,82

MT 224

Valvola 4 vie per fan coil / 4-ways valve for fan coil



Cod.	Size		€ / Cad.
MT022400500N	1/2"	10	38,23
MT022400700N	3/4"	10	38,84
MT022401000N	1"	10	45,25

TH 507

Attuatore elettrotermico con micro-switch per valvole fan coil 2-3-4 vie / Electrothermal actuator with micro-switch for 2-3-4 way fan coil valves



Cod.	Size		€ / Cad.
TH507000230	230 Volt	1	51,70
TH507000024	24 Volt	1	51,70

clicca il seguente link: www.assotherm.it o scannerizza il QR-Code per scaricare le schede tecniche dei prodotti



MT 063

Valvola 6 vie per fan coil / 6-ways valve for fan coil



Cod.	Size		€ / Cad.
MT006300005	DN 15 x 1/2"		125,00

MT 063M

Valvola 6 vie per fan coil / 6-ways valve for fan coil



Cod.	Size		€ / Cad.
MT0063M0005	DN 15 x 3/4" Eurokonus		121,00

MT 064

Attuatore elettrotermico con modalità di controllo proporzionale per valvole fan coil 6 vie / Electrothermal actuator with proportional control mode for 6-way fan coil valves



Cod.	Size		€ / Cad.
MT006400024V	24 Volt	1	200,00

clicca il seguente link: www.assotherm.it o scannerizza il QR-Code per scaricare le schede tecniche dei prodotti



ACCESSORI PER TERMOSIFONE





Accessori per termosifone



Accessories for radiator

DC 300

Raccordi con OR per valvole doppie (Art. MT 90 - MT 91) / Fittings with OR for double valves (Art. MT 90 - MT 91)



Cod.	Size		€ / Cad.
DC0300000705	3/4" x 1/2"	10	2,40

PR 112

Valvola sfogo aria manuale con o-ring / Manual air vent valve with o-ring



Cod.	Size		€ / Cad.
PR0112002000	1/4"	10	2,10
PR0112003000	3/8"	10	2,85
PR0112005000	1/2"	10	3,20

PR 113

Valvola sfogo aria con scarico / Air vent valve with drain



Cod.	Size		€ / Cad.
PR0113002000	1/4"	10	3,60
PR0113003000	3/8"	10	4,10

PR 286

Tappo per radiatore in alluminio (filetto destro o sinistro) / Aluminum radiator cap (right or left thread)



Cod.	Size		€ / Cad.
PR0028600100	1"	10	1,55

PR 287

Tappo con riduzione (filetto destro o sinistro) / Cap with reduction (right or left thread)



Cod.	Size		€ / Cad.
PR0287001010	1" x 1/8"	10	1,60
PR0287001020	1" x 1/4"	10	1,60
PR0287001030	1" x 3/8"	10	1,60
PR0287001050	1" x 1/2"	10	1,60
PR0287001070	1" x 3/4"	10	3,00

clicca il seguente link: www.assotherm.it o scannerizza il QR-Code per scaricare le schede tecniche dei prodotti



KIT RAD

Kit per radiatori in alluminio con 2 riduzioni dx e 2 sx, 1 valvola di scarico aria e 1 tappo con cappuccio, completo di guarnizioni / Aluminium radiators Kit with 2 reduction right and left, 1 air vent and 1 plug with cap, complete with gasket



Cod.	Size		€ / Cad.
KITRAD010030	1" - 3/8"	1	7,95
KITRAD010050	1" - 1/2"	1	7,95

PR 288C

Mensola a tassello per radiatore in alluminio / Anchor bracket for aluminium radiators



Cod.	Size		€ / Cad.
PR0288C00195	195mm	10	4,50

PR 29BC

Mensola per radiatore in alluminio / Anchor bracket for aluminium radiators



Cod.	Size		€ / Cad.
PR029BC00200	200mm	10	1,63

PR 120

Distanziatore eccentrico nichelato per radiatori / Eccentric nickel-plated spacer for radiators



Cod.	Size		€ / Cad.
PR0120050100	1/2" - 100	50	10,00
PR0120050200	1/2" - 200	50	12,00
PR0120050300	1/2" - 300	50	13,00
PR0120050400	1/2" - 400	50	14,00
PR0120050500	1/2" - 500	50	15,00
PR0120050600	1/2" - 600	50	17,00

PR 317C

Rosetta per finitura / Covering flanges



Cod.	Size		€ / Cad.
PR0317C00010	Ø 10	10	0,41
PR0317C00012	Ø 12	10	0,41
PR0317C00014	Ø 14	10	0,41
PR0317C00016	Ø 16	10	0,41
PR0317C00018	Ø 18	10	0,41

clicca il seguente link: www.assotherm.it o scannerizza il QR-Code per scaricare le schede tecniche dei prodotti



RIDUTTORI DI PRESSIONE



La rete pubblica di distribuzione dell'acqua, ha la necessità di avere valori elevati di pressione per garantire il fabbisogno idrico di ciascuna utenza.

I riduttori di pressione svolgono primaria funzione di mantenere costante la pressione a valle dell'impianto anche al variare della pressione a monte.

La tecnologia del riduttore di pressione garantisce quindi la stabilità dell'impianto, evitando danni importanti all'impianto per via dei sovraccarichi di pressione.



The public water distribution network needs to have high pressure values to ensure the water needs of each user.

Pressure reducers have the primary function of maintaining constant pressure downstream of the system even when the upstream pressure changes. The pressure reducer technology therefore ensures the stability of the system, avoiding major damage to the system due to pressure overloads.

**RD 130**

Riduttore di pressione sede acciaio inox PN 25 / Pressure reducer stainless steel set PN 25

Pressione nominale / Nominal Pressure : 25 bar

Temperatura max d'esercizio / Max operating temperature : +80 °C

Materiale / Material : Ottone



Cod.	Size			€ / Cad.
RD0013005000	1/2"	F / F	1	35,09
RD0013007000	3/4"	F / F	1	50,36
RD0013010000	1"	F / F	1	57,67
RD0013012000	1" 1/4	F / F	1	119,08
RD0013015000	1" 1/2	F / F	1	128,01
RD0013020000	2"	F / F	1	201,44
RD0013025000	2" 1/2	F / F	1	276,17
RD0013030000	3"	F / F	1	391,50
RD0013040000	4"	F / F	1	969,83

RD 140

Riduttore di pressione sede acciaio inox PN 25 con bocchettone / Pressure reducer stainless steel set PN 25 with nut and tail

Pressione nominale / Nominal Pressure : 25 bar

Temperatura max d'esercizio / Max operating temperature : +80 °C

Materiale / Material : Ottone



Cod.	Size			€ / Cad.
RD0014005000	1/2"	M / M	1	53,61
RD0014007000	3/4"	M / M	1	69,85
RD0014010000	1"	M / M	1	68,23
RD0014012000	1" 1/4	M / M	1	126,71
RD0014015000	1" 1/2	M / M	1	134,83
RD0014020000	2"	M / M	1	227,43

RD 150

Riduttore di pressione serie Mini PN15 / Pressure reducer Mini series PN15

Pressione nominale / Nominal Pressure : 15 bar

Temperatura max d'esercizio / Max operating temperature : +80 °C

Materiale / Material : Ottone



Cod.	Size			€ / Cad.
RD0015003000	3/8"	F / F	1	20,79
RD0015005000	1/2"	F / F	1	20,96
RD0015007000	3/4"	F / F	1	21,93

RD 151

Riduttore di pressione serie Mini PN15 / Pressure reducer Mini series PN15

Pressione nominale / Nominal Pressure : 15 bar

Temperatura max d'esercizio / Max operating temperature : +80 °C

Materiale / Material : Ottone



Cod.	Size			€ / Cad.
RD0015105000	1/2"	M / M	1	21,12
RD0015107000	3/4"	M / M	1	21,93

clicca il seguente link: www.assotherm.it o scannerizza il QR-Code per scaricare le schede tecniche dei prodotti



RD 104

Riduttore di pressione serie Mini PN15 con calotta girevole / Pressure reducer Mini series PN15 with turnable nut

Pressione nominale / Nominal Pressure : 15 bar

Temperatura max d'esercizio / Max operating temperature : +80 °C

Materiale / Material : Ottone



Cod.	Size		€ / Cad.
RD0104007070	3/4" - 3/4"	F / M	24,37

RD 105

Gruppo carico impianto Filtro e dispositivi di non ritorno integrato con attacco manometro / System loading unit Filter and non-return devices integrated with pressure gauge connection

Pressione nominale / Nominal Pressure : 16 bar

Temperatura max d'esercizio / Max operating temperature : +80 °C

Materiale / Material : Ottone



Cod.	Size		€ / Cad.
RD0105005000	1/2"		36,55

→ Manometro MI 016 escluso (ordinare separatamente) /
MI 016 pressure gauge not included (order separately)

RD 120

Riduttore di pressione sede acciaio inox PN 40 con bocchettone / Pressure reducer stainless steel PN 40 with nut and tail

Pressione nominale / Nominal Pressure : 40 bar

Temperatura max d'esercizio / Max operating temperature : +80 °C

Materiale / Material : Ottone



Cod.	Size		€ / Cad.
RD0012005000	1/2"	F / F	60,11
RD0012007000	3/4"	F / F	77,98
RD0012010000	1"	F / F	105,59

RD 159

Filtro autopulente 100micron PN25 / Self clearing filter 100micron PN25



Cod.	Size		€ / Cad.
RD0159005000	1/2"	F / F	101,53
RD0159007000	3/4"	F / F	103,16
RD0159010000	1"	F / F	120,21
RD0159012000	1" 1/4"	F / F	121,84
RD0159015000	1" 1/2"	F / F	151,08
RD0159020000	2"	F / F	152,70

RD 17

Valvola ammortizzatrice colpo D'ariete / Shock absorber anti-water hammer

Pressione nominale / Nominal Pressure : 10 bar

Pressione di picco / Peak pressure : 50 bar

Materiale / Material : Ottone



Cod.	Size		€ / Cad.
RD0170005000	1/2"	M	27,29

MI 15 / MI 16

Manometro attacco posteriore/radiale / Pressure gauge back/radial connection



Cod.	Size		€ / Cad.
MI0150000200	1/4"	POSTERIORE	9,10
MI0160000200	1/4"	RADIALE	9,10

clicca il seguente link: www.assotherm.it o scannerizza il QR-Code
per scaricare le schede tecniche dei prodotti



PRODOTTI COMPLEMENTARI ACQUA



Nella sezione viene elencata un'ampia gamma di prodotti in ottone per reti di distribuzione idrica e di riscaldamento come:

Rubinetteria per utenze sanitarie, Rubinetteria varia di intercettazione, valvole di ritegno e filtrazione, valvole di sicurezza e di scarico aria negli impianti.



The section lists a wide range of brass products for water distribution and heating networks such as:

Taps for sanitary utilities, various shut-off taps and fittings, check and filtration valves, safety valves and air discharger valves for plants.



Prodotti complementari acqua



Water complementary products

PI 88

Rubinetto sottolavabo lungo / Under washbasin long type



Cod.	Size		€ / Cad.
PI0088000510	1/2" x 10	25	5,36

PI 89

Rubinetto sottolavabo a sfera con filtro / Under washbasin bibcock with filter



Cod.	Size		€ / Cad.
PI0089000510	1/2" x 10	25	9,98

PI 299

Rubinetto lavatrice con rosetta / Washing machine tap with rosette



Cod.	Size		€ / Cad.
PI029900505C	1/2" - 1/2"	20	6,86
PI029900507C	1/2" - 3/4"	15	7,37

PI 300

Rubinetto doppio attacco lavatrice con ogiva / Under washbasin bibcock double outlet with washing machine connection and brass ogive



Cod.	Size		€ / Cad.
PI030000507C	1/2" - 3/4" x 10	25	15,39

PI 297

Rubinetto lavatrice con maniglia tre punte / Washing machine tap triangle handle



Cod.	Size		€ / Cad.
PI029700507C	1/2" - 3/4" x 10 DTRITTO	15	7,66

PI 296

Rubinetto lavatrice con maniglia inclinata / Washing machine tap with inclined handle



Cod.	Size		€ / Cad.
PI029600507C	1/2" - 3/4" x 10 CURVO	25	7,66

clicca il seguente link: www.assotherm.it o scannerizza il QR-Code per scaricare le schede tecniche dei prodotti



PI 136

Rubinetto da giardino / Garden tap



Cod.	Size		€ / Cad.
PI013600500N	1/2" - 3/4"	25	5,85
PI013601000N	1" - 3/4"	20	7,62

PI 132

Rubinetto in ottone cromato con portagomma / Chromed brass tap with hose connection



Cod.	Size		€ / Cad.
PI013200500N	1/2" - 3/4"	20	10,54

PI 133

Rubinetto in ottone giallo con portagomma / Yellow brass tap with hose connection



Cod.	Size		€ / Cad.
PI013300500N	1/2" - 3/4"	20	14,54

PI 5006

Prolunga ridotta cromata con dado / Chromium plated reduced extention



Cod.	Size		€ / Cad.
PI0500600510	1/2" x 10	25	3,89

PI 5007

Curvetta 90° / Chrome copper elbow



Cod.	Size		€ / Cad.
PI0500700510	1/2" x 10	25	7,50

clicca il seguente link: www.assotherm.it o scannerizza il QR-Code per scaricare le schede tecniche dei prodotti



PI 650

Valvola di ritegno in ottone con otturatore in nylon / Brass check valve with nylon shutter



Cod.	Size	PN		€ / Cad.
PI0650005000	1/2"	20	30	4,99
PI0650007000	3/4"	20	25	7,09
PI0650010000	1"	20	15	9,52
PI0650012000	1" 1/4	16	10	13,77
PI0650015000	1" 1/2	16	10	19,04
PI0650020000	2"	16	5	28,84

PI 650S

Valvola di ritegno con otturatore in INOX / Check valve with stainless steel shutter



Cod.	Size	PN		€ / Cad.
PI0650S05000	1/2"	25	30	8,11
PI0650S07000	3/4"	25	25	10,77
PI0650S10000	1"	25	15	15,70
PI0650S12000	1" 1/4	16	10	26,30
PI0650S15000	1" 1/2	16	10	34,61
PI0650S20000	2"	16	5	55,17
PI0650S25000	2" 1/2	10	1	112,10
PI0650S30000	3"	10	1	167,96
PI0650S40000	4"	10	1	254,16

PI 400

Valvola a clapet sede metallo (disponibile sede gomma) / Clapet valve metal seat (rubber seat available)



Cod.	Size	PN		€ / Cad.
PI0400005000	1/2"	10	20	8,30
PI0400007000	3/4"	10	15	11,50
PI0400010000	1"	10	10	16,30
PI0400012000	1" 1/4	10	5	22,00
PI0400015000	1" 1/2	10	5	33,40
PI0400020000	2"	10	1	46,10
PI0400025000	2" 1/2	6	1	70,15
PI0400030000	3"	6	1	100,45
PI0400040000	4"	4	1	163,11

PI 450

Valvola di fondo con filtro in ottone / Foot valve with brass strainer



Cod.	Size		€ / Cad.
PI0450007000	3/4"	20	9,20
PI0450010000	1"	15	11,20
PI0450012000	1" 1/4	10	17,70
PI0450015000	1" 1/2	5	22,20
PI0450020000	2"	1	35,00
PI0450025000	2" 1/2	1	55,60
PI0450030000	3"	1	71,05
PI0450040000	4"	1	135,00

clicca il seguente link: www.assotherm.it o scannerizza il QR-Code per scaricare le schede tecniche dei prodotti



VA 231

Saracinesca filettata in ottone PN16 / Brass gate valve threaded pattern PN16



Cod.	Size		€ / Cad.
VA0231005000	1/2"	F / F	20 8,11
VA0231007000	3/4"	F / F	15 11,38
VA0231010000	1"	F / F	10 16,90
VA0231012000	1" 1/4	F / F	5 23,25
VA0231015000	1" 1/2	F / F	5 27,80
VA0231020000	2"	F / F	5 43,95
VA0231025000	2" 1/2	F / F	1 61,31
VA0231030000	3"	F / F	1 80,45
VA0231040000	4"	F / F	1 140,30

PI 656

Fitro impurità in ottone ad Y / Brass Y filter



Cod.	Size		€ / Cad.
PI0656005000	1/2"	F / F	25 5,00
PI0656007000	3/4"	F / F	20 8,70
PI0656010000	1"	F / F	15 12,70
PI0656012000	1" 1/4	F / F	10 21,91
PI0656015000	1" 1/2	F / F	5 27,87
PI0656020000	2"	F / F	1 48,68
PI0656025000	2" 1/2	F / F	1 84,57
PI0656030000	3"	F / F	1 142,00
PI0656040000	4"	F / F	1 250,00

VA 60

Valvola di sicurezza (3-6 bar) / Safety valve (3-6 bar)



Cod.	Size		€ / Cad.
VA0060000503	1/2" - 3 bar	F-F	10 5,50
VA0060000506	1/2" - 6 bar	F-F	10 5,50
VA0060000703	3/4" - 3 bar	F-F	10 9,00
VA0060000706	3/4" - 6 bar	F-F	10 9,00
VA0060001003	1" - 3 bar	F-F	10 16,50
VA0060001006	1" - 6 bar	F-F	10 16,50

→ Solare termico a richiesta / Solar thermal on demand

VA 61

Valvola di sicurezza (3-6 bar) / Safety valve (3-6 bar)



Cod.	Size		€ / Cad.
VA0061000503	1/2" - 3 bar	M-F	10 5,50
VA0061000506	1/2" - 6 bar	M-F	10 5,50

→ Solare termico a richiesta / Solar thermal on demand

VA 59

Valvola di sicurezza a membrana ISPESL (2,7 - 6 bar) / Adjustable safety valve ISPESL (2,7 - 6 bar)



Cod.	Size		€ / Cad.
VA005900050	1/2" - 3/4"		1 87,68
VA005900070	3/4" - 1"		1 125,85
VA005900100	1" - 1" 1/4		1 253,03
VA005900120	1" 1/4 - 1" 1/2		1 432,44

Varianti / Choices: 2,7 / 3 / 3,5 / 4 / 4,5 / 5 / 5,4 / 6 bar

→ Specificare taratura in fase d'ordine / Specify calibration on demand

clicca il seguente link: www.assotherm.it o scannerizza il QR-Code
per scaricare le schede tecniche dei prodotti



VA 110

Valvola di sfogo aria automatica / Automatic air-discharger valve



Cod.	Size		€ / Cad.
VA0110000300	3/8"	10	7,18
VA0110000500	1/2"	10	7,18
VA0110000700	3/4"	10	8,14
VA0110001000	1"	10	9,88

VAX 110

Valvola di sfogo aria automatica per impianti solari / Automatic air-discharger valve for solar panel

Pressione nominale / Nominal Pressure : 10 bar Temperatura d'esercizio max / Max operating temperature : 200°C Materiale / Material : Ottone



Cod.	Size		€ / Cad.
VAX011000300	3/8"	10	12,00
VAX011000500	1/2"	10	12,00

VA 63

Valvola di sfogo aria automatica attacco 90° / Automatic air-discharger valve 90°



Cod.	Size		€ / Cad.
VA0063000030	3/8"	10	8,28
VA0063000050	1/2"	10	8,28

PI 99F

Minivalvola / Mini valve



Cod.	Size			€ / Cad.
PI0099F00200	1/4"	F / F	30	4,19
PI0099F00300	3/8"	F / F	25	4,19
PI0099F00500	1/2"	F / F	20	4,83

→ Serie Pesante [PI 99FS](#) / Heavy Series [PI 99FS](#)

PI 99M

Minivalvola / Mini valve



Cod.	Size			€ / Cad.
PI0099M00200	1/4"	M / F	30	3,55
PI0099M00300	3/8"	M / F	25	3,55
PI0099M00500	1/2"	M / F	20	4,41
PI0099M00700	3/4"	M / F	10	7,84

→ Serie Pesante [PI 99MS](#) / Heavy Series [PI 99MS](#)

clicca il seguente link: www.assotherm.it o scannerizza il QR-Code per scaricare le schede tecniche dei prodotti



PI 96

Scarico caldaia con portagomma / Drain cock for boiler



Cod.	Size			€ / Cad.
PI0096005000	1/2"	M	10	6,24
PI0096007000	3/4"	M	10	8,77

SP 100

Portamanometro con flangia / Manometer holder with flange



Cod.	Size			€ / Cad.
SP0100000200	1/4"	M / F	20	11,42
SP0100000300	3/8"	M / F	20	12,86
SP0100000500	1/2"	M / F	20	14,27

SP 101

Portamanometro / Manometer holder



Cod.	Size			€ / Cad.
SP0101000200	1/4"	M / F	20	7,36
SP0101000300	3/8"	M / F	20	7,82
SP0101000500	1/2"	M / F	20	8,50

SP 102

Portamanometro / Manometer holder



Cod.	Size			€ / Cad.
SP0102000200	1/4"	F / F	20	7,41
SP0102000300	3/8"	F / F	20	7,82
SP0102000500	1/2"	F / F	20	9,00

SP 103

Ricciolo per manometro / Manometer curls



Cod.	Size			€ / Cad.
SP0103000200	1/4"	M / F	20	10,49
SP0103000300	3/8"	M / F	20	11,11
SP0103000500	1/2"	M / F	20	12,78

clicca il seguente link: www.assotherm.it o scannerizza il QR-Code per scaricare le schede tecniche dei prodotti



STRUMENTI DI MISURAZIONE E INTERCETTAZIONE



Nella sezione viene elencata un'ampia gamma di prodotti legati al rilievo e alla misurazione di temperatura e pressione negli impianti.



The section lists a wide range of products related to the survey and measurement of plants temperature and pressure.

**MI 629**

Manometro 0 - 10 bar / Pressure gauge 0 - 10 bar



Cod.	Size	Ø	Attacco / Connection		€ / Cad.
MI0629102063	1/4"	63	Radiale / Radial	25	8,84
MI0629103080	3/8"	80	Radiale / Radial	25	13,98
MI0629105100	1/2"	100	Radiale / Radial	25	25,82

→ Personalizzazione su richiesta / Logo on demand

MI 629S

Manometro 0 - 6 bar / Pressure gauge 0 - 6 bar



Cod.	Size	Ø	Attacco / Connection		€ / Cad.
MI0629S62063	1/4"	63	Radiale / Radial	25	8,84
MI0629S63080	3/8"	80	Radiale / Radial	25	13,98
MI0629S65100	1/2"	100	Radiale / Radial	25	25,82

→ Personalizzazione su richiesta / Logo on demand

MI 630

Termometro INAIL 0 - 120 °C / Thermometer INAIL 0 - 120 °C



Cod.	Size	Ø	Attacco / Connection		€ / Cad.
MI0630005050	1/2" x 50	80	Radiale / Radial	25	28,18
MI0630005100	1/2" x 100	80	Radiale / Radial	25	30,26

→ Personalizzazione su richiesta / Logo on demand

MI 630V

Termometro -30 ↔ +50 °C / Thermometer -30 ↔ +50 °C



Cod.	Size	Ø	Attacco / Connection		€ / Cad.
MI0630V05070	1/2" x 70	80	Radiale / Radial	25	29,60
MI0630V05100	1/2" x 100	80	Radiale / Radial	25	31,78

→ Personalizzazione su richiesta / Logo on demand

MI 631

Termometro 0 - 120 °C / Thermometer 0 - 120 °C



Cod.	Size	Ø	Attacco / Connection		€ / Cad.
MI0631005050	1/2" x 50	80	Posteriore / Back	25	10,09
MI0631005100	1/2" x 100	80	Posteriore / Back	25	11,02

→ Personalizzazione su richiesta / Logo on demand

clicca il seguente link: www.assotherm.it o scannerizza il QR-Code
per scaricare le schede tecniche dei prodotti



MI 631V

Termometro -30 ↔ +50 °C / Thermometer -30 ↔ +50 °C



Cod.	Size	Ø	Attacco / Connection		€ / Cad.
MI0631V05050	1/2" x 50	80	Posteriore / Back	25	10,61
MI0631V05100	1/2" x 100	80	Posteriore / Back	25	13,31

→ Personalizzazione su richiesta / Logo on demand

MI 627

Manometro con glicerina / Glycerine pressure gauge



Cod.	Size	Ø	Attacco / Connection		€ / Cad.
MI0627C00042	1/4"	63	0 - 4 bar	25	29,45
MI0627C00062	1/4"	63	0 - 6 bar	25	29,45
MI0627C00102	1/4"	63	0 - 10 bar	25	29,45
MI0627C00162	1/4"	63	0 - 16 bar	25	29,45
MI0627C00252	1/4"	63	0 - 25 bar	25	29,45
MI0627C00402	1/4"	63	0 - 40 bar	25	29,45
MI0627C00602	1/4"	63	0 - 60 bar	25	29,45

MI 620

Idrometro / Hydrometer



Cod.	Size	Ø	Attacco / Connection		€ / Cad.
MI0620003016	3/8"	80	0 - 16 m H ₂ O	25	19,34
MI0620003025	3/8"	80	0 - 25 m H ₂ O	25	19,34
MI0620003040	3/8"	80	0 - 40 m H ₂ O	25	19,34

MI 626

Manometro GAS / GAS Pressure gauge



Cod.	Size	Ø	Attacco / Connection		€ / Cad.
MI0626C00602	1/4"	63	0 - 60 mm H ₂ O	25	57,31
MI0626C01002	1/4"	63	0 - 100 mm H ₂ O	25	57,31
MI0626C02502	1/4"	63	0 - 250 mm H ₂ O	25	57,31

→ Altre misura a richiesta / Other sizes on demand

MI 635

Pozzetto per termometro / Brass testing pocket



Cod.	Size		€ / Cad.
MI0635005050	1/2" x 50	20	5,60
MI0635005100	1/2" x 100	20	8,91

clicca il seguente link: www.assotherm.it o scannerizza il QR-Code
per scaricare le schede tecniche dei prodotti



MI 632

Pressostato di sicurezza Ispesl, riarmo manuale / Manual reset safety pressure switch type



Cod.	Size		€ / Cad.
MI0632000100	1/4"	1 - 5 Bar	50,42

MI 638

Pressostato di minima a riarmo manuale, Ispesl / Minimum pressure switch with manual reset, Ispesl



Cod.	Size		€ / Cad.
MI0638000100	1/4"	0.5 - 1.7 bar	66,40

MI 420

Termostato di sicurezza ad immersione, riarmo manuale INAIL / Immersion safety thermostat INAIL



Cod.	Size		€ / Cad.
MI0420000500	1/2"	0 - 100 °C	63,62

MI 633

Termostato regolabile ad immersione / Adjustable immersion thermostat



Cod.	Size		€ / Cad.
MI0633000500	1/2"	0 - 90 °C	57,89

MI 639

Bitermostato immersione regolabile / Adjustable immersion bi-thermostat



Cod.	Size		€ / Cad.
MI0639000500	1/2"	0 - 90 °C	121,38

clicca il seguente link: www.assotherm.it o scannerizza il QR-Code per scaricare le schede tecniche dei prodotti



MI 637

Pozzetto per sonda / Probe poket



Cod.	Size		€ / Cad.
MI06370050100	1/2"	100 mm	11,00
MI06370050150	1/2"	150 mm	15,50
MI06370050200	1/2"	200 mm	22,00

MI 419

Termostato a contatto bimetallico / Bimetallic contact thermostat



Cod.	Size		€ / Cad.
MI0419000500	1/2"	20 - 90 °C	45,00

MI 634

Flussometro per tubazioni da 1" a 8" / Flowmeter for pipes from 1" to 8"



Cod.	Size		€ / Cad.
MI0634000010	1"		186,01

MI 417

Cronotermostato riscaldamento e condizionamento / Chronothermostat for heating and air conditioning



Cod.			€ / Cad.
MI0417000000	Touch Screen	1	

→ Prezzi netti a richiesta / Net prices on demand

MI 418

Termostato ambiente elettromeccanico / Electromechanical room thermostat



Cod.			€ / Cad.
MI0418000000		1	

→ Prezzi netti a richiesta / Net prices on demand

clicca il seguente link: www.assotherm.it o scannerizza il QR-Code
per scaricare le schede tecniche dei prodotti



ELETTROVALVOLE, FILTRI GAS E ACCESSORI CENTRALE TERMICA



Rientrano nella categoria di questa sezione del Catalogo Assotherm i componenti per centrale termica, per l'intercettazione di fluidi liquidi e gassosi.

Esempio di prodotti della sezione sono le elettrovalvole, i filtri regolatori gas, valvole di intercettazione del combustibile e di scarico termico.



The components for thermal power plants, for the interception of liquid and gaseous fluids, are part of this section of the Assotherm Catalogue.

Examples of this category products are solenoid valves, gas regulator filters, fuel shut-off valves and thermal discharge valves.

**FC 640**

Elettrovalvola gas normalmente chiusa 230V, riarmo manuale / 230V gas solenoid valve normally closed, manual reset



Cod.	Size			€ / Cad.
FC0640000005	1/2"	550 mbar	1	142,63
FC0640000007	3/4"	550 mbar	1	144,21
FC0640000010	1"	550 mbar	1	171,79
FC0640000012	1" 1/4	550 mbar	1	230,25
FC0640000015	1" 1/2	550 mbar	1	230,25
FC0640000020	2"	550 mbar	1	278,37
FC0640000065	DN 65	550 mbar	1	857,67
FC0640000080	DN 80	550 mbar	1	864,71
FC0640000100	DN 100	550 mbar	1	1334,13

FC 641

Elettrovalvola gas normalmente aperta 230V, riarmo manuale / 230V gas solenoid valve normally open, manual reset



Cod.	Size			€ / Cad.
FC0641000005	1/2"	550 mbar	1	91,00
FC0641000007	3/4"	550 mbar	1	91,00
FC0641000010	1"	550 mbar	1	130,00
FC0641000012	1" 1/4	550 mbar	1	185,87
FC0641000015	1" 1/2	550 mbar	1	185,87
FC0641000020	2"	550 mbar	1	218,91
FC0641000065	DN 65	550 mbar	1	605,73
FC0641000080	DN 80	550 mbar	1	615,21
FC0641000100	DN 100	550 mbar	1	1063,37

FC 642

Filtro gas omologato CE / CE approved gas filter



Cod.	Size			€ / Cad.
FC0642000005	1/2"		1	47,54
FC0642000007	3/4"		1	47,54
FC0642000010	1"		1	47,54
FC0642000012	1" 1/4		1	78,71
FC0642000015	1" 1/2		1	78,71
FC0642000020	2"		1	97,10
FC0642000065	DN 65		1	405,78
FC0642000080	DN 80		1	435,95
FC0642000100	DN 100		1	710,01

FC 643

Filtro regolatore a chiusura per gas omologato CE / CE approved closing filter regulator for gas



Cod.	Size			€ / Cad.
FC0643000005	1/2"		1	120,00
FC0643000007	3/4"		1	120,00
FC0643000010	1"		1	125,00
FC0643000012	1" 1/4		1	261,14
FC0643000015	1" 1/2		1	261,14
FC0643000020	2"		1	395,01
FC0643000065	DN 65		1	1160,90
FC0643000080	DN 80		1	1170,38
FC0643000100	DN 100		1	2029,06

clicca il seguente link: www.assotherm.it o scannerizza il QR-Code
per scaricare le schede tecniche dei prodotti



FC 644

Valvola di intercettazione combustibile ISPEL / Fuel shut-off valve ISPEL



Cod.	Size		€ / Cad.
FC0644000005	1/2"	1	410,00
FC0644000007	3/4"	1	410,00
FC0644000010	1"	1	513,94
FC0644000012	1" 1/4	1	629,00
FC0644000015	1" 1/2	1	690,00
FC0644000020	2"	1	840,00
FC0644000065	DN 65	1	1380,00
FC0644000080	DN 80	1	1570,00
FC0644000100	DN 100	1	2830,00

FC 206

Valvola di scarico termico ISPEL, ad azione positiva, con riarmo manuale / ISPEL thermal relief valve, positive action and manual reset



Cod.	Size		€ / Cad.
FC0206000012	1" 1/4	1	1223,53
FC0206000015	1" 1/2	1	1610,78

FC 187

Giunto antivibrante GAS / Anti-vibration GAS joint



Cod.	Size				€ / Cad.
FC0187000500	1/2"	M / M	0,5 bar	1	10,50
FC0187000700	3/4"	M / M	0,5 bar	1	12,50
FC0187001000	1"	M / M	0,5 bar	1	18,00
FC0187001200	1" 1/4	M / M	0,5 bar	1	26,50
FC0187001500	1" 1/2	M / M	0,5 bar	1	36,00
FC0187002000	2"	M / M	0,5 bar	1	48,00

FC 188

Giunto antivibrante GAS flangiato / Flanged anti-vibration joint GAS

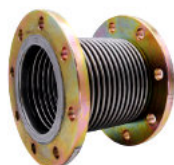

Cod.	Size		€ / Cad.
FC0188000065	DN 65	1	199,52
FC0188000080	DN 80	1	275,65
FC0188000100	DN 100	1	324,63

clicca il seguente link: www.assotherm.it o scannerizza il QR-Code per scaricare le schede tecniche dei prodotti



PL 54

Giunto dielettrico per GAS / Dielectric joint for GAS



Cod.	Size			€ / Cad.
PL0540000005	1/2"	M / F	0,5 bar	33,51
PL0540000007	3/4"	M / F	0,5 bar	35,50
PL0540000010	1"	M / F	0,5 bar	38,50
PL0540000012	1" 1/4	M / F	0,5 bar	50,96
PL0540000015	1" 1/2	M / F	0,5 bar	60,00
PL0540000020	2"	M / F	0,5 bar	80,00
PL0540000025	2" 1/2	M / F	0,5 bar	190,00
PL0540000030	3"	M / F	0,5 bar	260,00

FC 150

Disaeratore per impianto riscaldamento / Deaerator for heating system



Cod.	Size		€ / Cad.
FC0150000010	1"		359,63
FC0150000012	1" 1/4		376,92
FC0150000015	1" 1/2		472,54
FC0150000020	2"		616,04
FC0150000065	DN 65		1500,00
FC0150000080	DN 80		1800,00

CS 112C

Compensatore idraulico per impianto riscaldamento / Hydraulic compensator for heating system



Cod.	Size		€ / Cad.
CS112C003010	3" x 1"		328,34
CS112C004012	4" x 1" 1/4		449,19
CS112C004015	4" x 1" 1/2		470,29
CS112C005020	5" x 2"		519,05
CS112C006065	6" x DN 65		1140,10
CS112C008080	8" x DN 80		1480,89
CS112C010100	10" x DN 100		2212,26

→ Con coibentazione / Insulated

CS 113C

Defangatore idraulico per impianto riscaldamento / Hydraulic dirt separator for heating system



Cod.	Size		€ / Cad.
CS113C003010	3" x 1"		416,00
CS113C004012	4" x 1" 1/4		495,70
CS113C004015	4" x 1" 1/2		553,63
CS113C005020	5" x 2"		647,34
CS113C006065	6" x DN 65		971,35
CS113C008080	8" x DN 80		1554,03
CS113C010100	10" x DN 100		1953,60

→ Con coibentazione / Insulated

clicca il seguente link: www.assotherm.it o scannerizza il QR-Code
per scaricare le schede tecniche dei prodotti



FILTRI MAGNETICI MULTIFUNZIONE



FILTRO MAGNETICO MULTIFUNZIONE

Azione Ciclonica, Magnetica e Filtrante

- Elimina tutte le impurità
- Autopulente
- Ottime caratteristiche idrauliche
- Montaggio su tubazioni verticali, orizzontali e diagonali
- Prolunga la vita della caldaia
- Combatte la corrosione
- Garantisce l'efficienza dell'impianto
- Facile dosaggio dei fluidi di trattamento
- Valvole di intercettazione a passaggio totale



MULTIFUNCTION MAGNETIC DIRT SEPARATOR

Vortex , Magnetic and Strainer Action

- Retains all impurities
- Self-cleaning
- Excellent hydraulic properties
- Can be mounted on vertical, horizontal and diagonal piping
- Increases the lifespan of the boiler
- Fights corrosion
- Maintains optimum system efficiency
- Easy dosing of the treatment fluids

Specifiche Tecniche

Temperatura massima di esercizio	90°C
Pressione massima di esercizio	3 bar
Attacchi filettati	ISO 228/1
Capacità Serbatoio	0,5 L

Technical Specification

Maximum working Temperature	90°C
Maximum working Pressure	3 bar
Threads	ISO 228/1
Tank Capacity	0,5 L

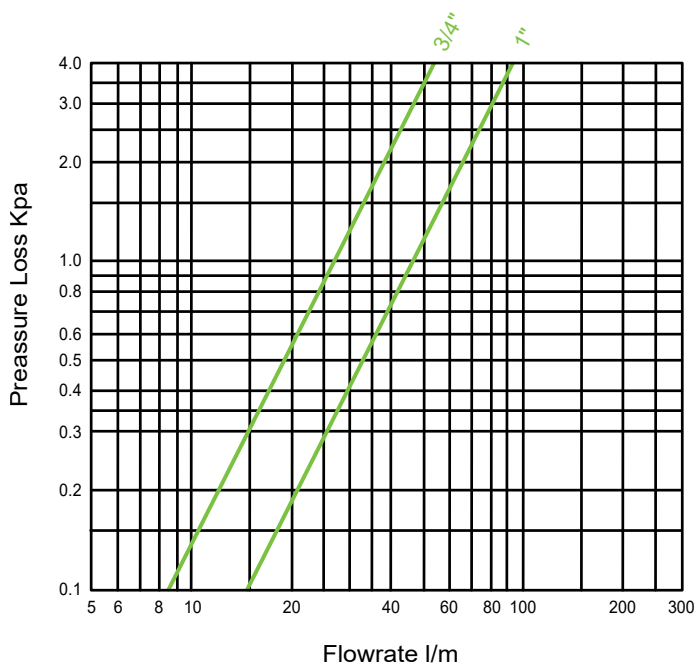
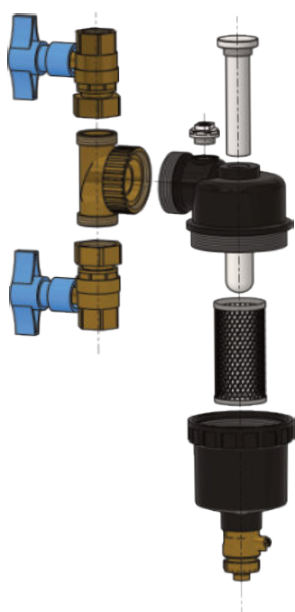

FC 116

Filtro defangatore magnetico multifunzione completo di valvole (pompa di calore) / Multifunction magnetic dirt separator with valves (heat pump)



Cod.	Size	📦	€ / Cad.
FC0116000007	3/4"	1	115,00
FC0116000010	1"	1	120,00

VS 142

Valvola a sfera con dado girevole / Ball valve with turnable nut



Cod.	Size	📦	€ / Cad.
VS0142007PNO	3/4" - 1"	1	15,00
VS0142010PNO	1" - 1"	1	16,00

clicca il seguente link: www.assotherm.it o scannerizza il QR-Code per scaricare le schede tecniche dei prodotti



Specifiche Tecniche

Temperatura massima di esercizio	90°C
Pressione massima di esercizio	10 bar
Attacchi filettati	ISO 228/1
Capacità Serbatoio	0.29L

Technical Specification

Maximum working Temperature	90°C
Maximum working Pressure	10 bar
Threads	ISO 228/1
Tank Capacity	0.29L

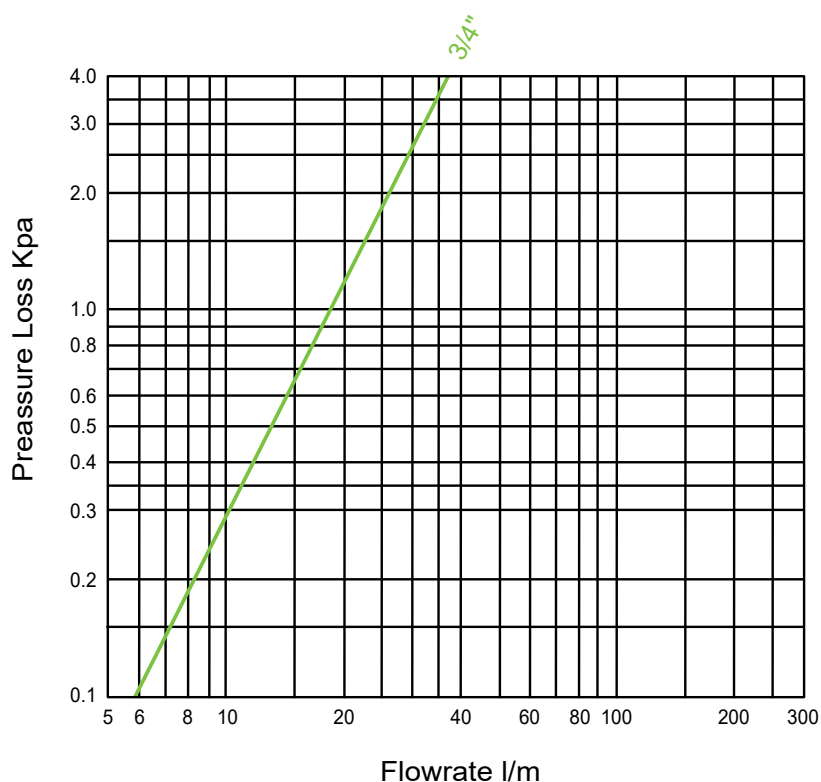

FC 113

Filtro defangatore magnetico multifunzione compatto (sotto caldaia) / Compact multifunction magnetic dirt separator (under-boiler)



Cod.	Size		€ / Cad.
FC0113000007	3/4"	1	50,00

clicca il seguente link: www.assotherm.it o scannerizza il QR-Code per scaricare le schede tecniche dei prodotti



VALVOLE A SFERA

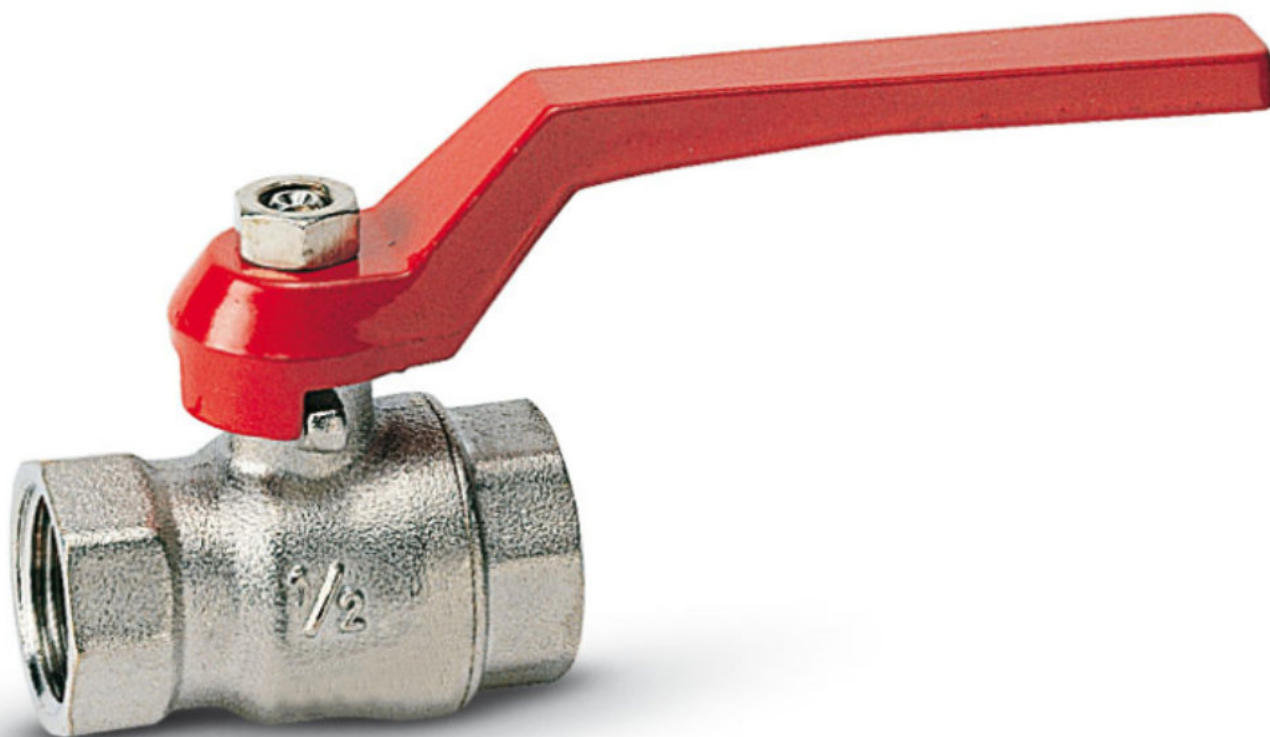

Particolarmente indicate per l'intercettazione di fluidi non corrosivi compatibili con la materia prima usata per la produzione della valvola.

I principali campi di applicazione sono nell'installazione termoidraulica, industria e agricoltura.

Standard con maniglia rossa in alluminio a leva o a farfalla, è personalizzabile nel colore Blu o nella versione in acciaio zincato ricoperta in ABS.

Si consiglia la manovra periodica della valvola per evitare il blocco dovuto alla formazione di calcare sulle sedi.



The valve is particularly indicated for distributing and sgutting off generally non-corrosive fluids that are compatible with the valve materials.

Excellent field of applications are in plant engineering for plumbing and heating, industry and agriculture.

The valve is standard supplied with red aluminium lever or butterfly handle. On demand, Blue and Galvanized Steel lever.

It is advisable to perform a complete manoeuvring periodically to prevent the formation of limescale, that can affect operation.



Valvole a sfera serie "silver" PN25



Ball valves serie "silver" PN25

VS 137

Valvola a sfera passaggio standard / Ball valve standard bore

Pressione nominale / Nominal Pressure : 25 bar

Temperatura d'esercizio / Operating temperature : -10 ↔ +95 °C

Materiale / Material : CW617N



Cod.	Size			€ / cad.
VS0137005ARN	1/2 "	F / F	160	4,71
VS0137007ARN	3/4 "	F / F	120	7,19
VS0137010ARN	1 "	F / F	60	11,33

VS 137P

Valvola a sfera passaggio standard / Ball valve standard bore

Pressione nominale / Nominal Pressure : 25 bar

Temperatura d'esercizio / Operating temperature : -10 ↔ +95 °C

Materiale / Material : CW617N



Cod.	Size			€ / cad.
VS0137P05PRN	1/2"	F / F	160	4,71
VS0137P07PRN	3/4"	F / F	120	7,19
VS0137P10PRN	1"	F / F	60	11,77

VS 137M

Valvola a sfera passaggio standard / Ball valve standard bore

Pressione nominale / Nominal Pressure : 25 bar

Temperatura d'esercizio / Operating temperature : -10 ↔ +95 °C

Materiale / Material : CW617N



Cod.	Size			€ / cad.
VS0137M05ARN	1/2"	M / F	160	5,31
VS0137M07ARN	3/4"	M / F	120	7,72
VS0137M10ARN	1"	M / F	60	12,15

VS 137MP

Valvola a sfera passaggio standard / Ball valve standard bore

Pressione nominale / Nominal Pressure : 25 bar

Temperatura d'esercizio / Operating temperature : -10 ↔ +95 °C

Materiale / Material : CW617N



Cod.	Size			€ / cad.
VS0137M05PRN	1/2"	M / F	160	5,31
VS0137M07PRN	3/4"	M / F	120	7,72
VS0137M10PRN	1"	M / F	60	12,37

VS 138

Valvola a sfera passaggio standard / Ball valve standard bore

Pressione nominale / Nominal Pressure : 25 bar

Temperatura d'esercizio / Operating temperature : -10 ↔ +95 °C

Materiale / Material : CW617N



Cod.	Size			€ / cad.
VS0138005ARN	1/2"	M / M	160	7,93
VS0138007ARN	3/4"	M / M	120	11,08
VS0138010ARN	1"	M / M	60	12,37

clicca il seguente link: www.assotherm.it o scannerizza il QR-Code per scaricare le schede tecniche dei prodotti



VS 138P

Valvola a sfera passaggio standard / Ball valve standard bore

Pressione nominale / Nominal Pressure : 25 bar

Temperatura d'esercizio / Operating temperature : -10 ↔ +95 °C

Materiale / Material : CW617N



Cod.	Size		€ / cad.
VS0138005PRN	1/2"	M / M	160 7,93
VS0138007PRN	3/4"	M / M	120 11,08
VS0138010PRN	1"	M / M	60 12,37

VS 141

Valvola a sfera passaggio integrale / Ball valve full bore

Pressione nominale / Nominal Pressure : 25 bar

Temperatura d'esercizio / Operating temperature : -10 ↔ +95 °C

Materiale / Material : CW617N



Cod.	Size		€ / cad.
VS0141003ARN	3/8"	F / F	160 5,28
VS0141005ARN	1/2"	F / F	160 5,28
VS0141007ARN	3/4"	F / F	120 8,10
VS0141010ARN	1"	F / F	60 12,85
VS0141012ARN	1" 1/4	F / F	48 19,86
VS0141015ARN	1" 1/2	F / F	24 28,78
VS0141020ARN	2"	F / F	12 45,13
VS0141025ARN	2" 1/2	F / F	6 98,68
VS0141030ARN	3"	F / F	2 183,90
VS0141040ARN	4"	F / F	1 296,95

VS 141P

Valvola a sfera passaggio integrale / Ball valve full bore

Pressione nominale / Nominal Pressure : 25 bar

Temperatura d'esercizio / Operating temperature : -10 ↔ +95 °C

Materiale / Material : CW617N



Cod.	Size		€ / cad.
VS0141003PRN	3/8"	F / F	160 5,28
VS0141005PRN	1/2"	F / F	160 5,28
VS0141007PRN	3/4"	F / F	120 8,10
VS0141010PRN	1"	F / F	60 12,85

VS 147

Valvola a sfera passaggio integrale / Ball valve full bore

Pressione nominale / Nominal Pressure : 25 bar

Temperatura d'esercizio / Operating temperature : -10 ↔ +95 °C

Materiale / Material : CW617N



Cod.	Size		€ / cad.
VS0147003ARN	3/8"	M / F	160 5,58
VS0147005ARN	1/2"	M / F	160 5,93
VS0147007ARN	3/4"	M / F	120 9,09
VS0147010ARN	1"	M / F	60 14,30
VS0147012ARN	1" 1/4	M / F	48 21,95
VS0147015ARN	1" 1/2	M / F	24 31,44
VS0147020ARN	2"	M / F	12 50,63

VS 147P

Valvola a sfera passaggio integrale / Ball valve full bore

Pressione nominale / Nominal Pressure : 25 bar

Temperatura d'esercizio / Operating temperature : -10 ↔ +95 °C

Materiale / Material : CW617N



Cod.	Size		€ / cad.
VS0147003PRN	3/8"	M / F	160 5,58
VS0147005PRN	1/2"	M / F	160 5,93
VS0147007PRN	3/4"	M / F	120 8,85
VS0147010PRN	1"	M / F	60 14,30

clicca il seguente link: www.assotherm.it o scannerizza il QR-Code per scaricare le schede tecniche dei prodotti



VS 148

Valvola a sfera passaggio integrale / Ball valve full bore

Pressione nominale / Nominal Pressure : 25 bar

Temperatura d'esercizio / Operating temperature : -10 ↔ +95 °C

Materiale / Material : CW617N



Cod.	Size		€ / cad.
VS0148005ARN	1/2" M / M	20	8,64
VS0148007ARN	3/4" M / M	15	12,03
VS0148010ARN	1" M / M	10	19,27

VS 148P

Valvola a sfera passaggio integrale / Ball valve full bore

Pressione nominale / Nominal Pressure : 25 bar

Temperatura d'esercizio / Operating temperature : -10 ↔ +95 °C

Materiale / Material : CW617N



Cod.	Size		€ / cad.
VS0148005PRN	1/2" M / M	25	8,64
VS0148007PRN	3/4" M / M	20	12,03
VS0148010PRN	1" M / M	15	19,27

VS 146B

Valvola a sfera passaggio integrale bocchettone dritta / Ball valve full bore nut and tail - straight pattern

Pressione nominale / Nominal Pressure : 25 bar

Temperatura d'esercizio / Operating temperature : -10 ↔ +95 °C

Materiale / Material : CW617N



Cod.	Size		€ / cad.
VS0146B05PRN	1/2" M / F	120	9,10
VS0146B07PRN	3/4" M / F	90	13,39
VS0146B10PRN	1" M / F	60	20,55

VS 146A

Valvola a sfera passaggio integrale bocchettone 90° a squadra / Ball valve full bore nut and tail 90° - angle pattern

Pressione nominale / Nominal Pressure : 25 bar

Temperatura d'esercizio / Operating temperature : -10 ↔ +95 °C

Materiale / Material : CW617N



Cod.	Size		€ / cad.
VS0146A07PRN	3/4" M / F	80	21,49
VS0146A10PRN	1" M / F	40	31,03

VS 144

Valvola a sfera passaggio integrale con spurgo / Ball valve full bore with drain

Pressione nominale / Nominal Pressure : 25 bar

Temperatura d'esercizio / Operating temperature : -10 ↔ +95 °C

Materiale / Material : CW617N



Cod.	Size		€ / cad.
VS0144005ARN	1/2" F / F	80	9,50
VS0144007ARN	3/4" F / F	60	13,47
VS0144010ARN	1" F / F	40	19,03

clicca il seguente link: www.assotherm.it o scannerizza il QR-Code per scaricare le schede tecniche dei prodotti



VS 374

Prolunga per maniglia valvola a sfera / Brass extention for ball valve lever



Cod.	Size		€ / cad.
VS0374000001	1/2" - 3/4"	10	6,25
VS0374000002	1" - 1" 1/4	10	7,74
VS0374000003	1" 1/2 - 2"	5	9,97
VS0374000004	2"1/2 - 3" - 4"	5	35,45

Per leva di comando diversa aggiungere il seguente codice finale:
For different control lever change the following final code:



PBN



ABN



FBN



FRN

VA 600

Valvola a sfera ad incasso con cappuccio cromato / Ball valve full bore built-in



Cod.	Size			€ / cad.
VA060000500N	1/2"	F / F	10	16,16
VA060000700N	3/4"	F / F	5	21,69

VA 605

Valvola a sfera ad incasso con maniglia cromata / Ball valve full bore built-in chromed handle



Cod.	Size			€ / cad.
VA060500500N	1/2"	F / F	8	16,59
VA060500700N	3/4"	F / F	6	23,06

clicca il seguente link: www.assotherm.it o scannerizza il QR-Code
per scaricare le schede tecniche dei prodotti





Valvole a sfera per contatore



Ball valves for water meter

VS 720

Valvola a sfera avant-contatore con dado girevole - dritta / Brass ball valve for water meter with turnable nut - straight pattern

Pressione nominale / Nominal Pressure : 25 bar Temperatura d'esercizio / Operating temperature : -20 ↔ +120 °C Materiale / Material : Ottone



Cod.	Size			€ / cad.
VS0720050700	1/2" x 3/4"	F / F	10	
VS0720070700	3/4" x 3/4"	F / F	10	

→ Solo su ordinazione / Only on demand

VS 721

Valvola a sfera avant-contatore con dado girevole - dritta / Brass ball valve for water meter with turnable nut - straight pattern

Pressione nominale / Nominal Pressure : 25 bar Temperatura d'esercizio / Operating temperature : -20 ↔ +120 °C Materiale / Material : Ottone



Cod.	Size			€ / Cad.
VS0721050700	M 1/2" x F 3/4"		10	
VS0721070700	M 3/4" x F 3/4"		10	

→ Solo su ordinazione / Only on demand

VS 722

Valvola a sfera avant-contatore 90° con dado girevole - a squadra / Brass ball valve for water meter 90° with turnable nut - angle pattern

Pressione nominale / Nominal Pressure : 25 bar Temperatura d'esercizio / Operating temperature : -20 ↔ +120 °C Materiale / Material : Ottone



Cod.	Size			€ / Cad.
VS0722050700	1/2" x 3/4"	F / F	10	
VS0722070700	3/4" x 3/4"	F / F	10	

→ Solo su ordinazione / Only on demand

VS 723

Valvola a sfera avant-contatore 90° con dado girevole - a squadra / Brass ball valve for water meter 90° with turnable nut - angle pattern

Pressione nominale / Nominal Pressure : 25 bar Temperatura d'esercizio / Operating temperature : -20 ↔ +120 °C Materiale / Material : Ottone



Cod.	Size			€ / Cad.
VS0723050700	M 1/2" x F 3/4"		10	
VS0723070700	M 3/4" x F 3/4"		10	

→ Solo su ordinazione / Only on demand

clicca il seguente link: www.assotherm.it o scannerizza il QR-Code per scaricare le schede tecniche dei prodotti





Valvole a sfera INOX AISI 316L



Stainless Steel Ball Valves

VSX 141

Valvole a sfera INOX AISI 316L passaggio integrale / Stainless Steel ball valve full bore

Pressione nominale / Nominal Pressure : 64 bar

Temperatura d'esercizio / Operating temperature : -10 ↔ +150 °C

Materiale / Material : INOX AISI 316



Cod.	Size			€ / Cad.
VSX141000200	1/4"	F / F	20	14,37
VSX141000300	3/8"	F / F	20	15,66
VSX141000500	1/2"	F / F	20	16,98
VSX141000700	3/4"	F / F	20	24,42
VSX141001000	1"	F / F	15	32,64
VSX141001200	1" 1/4"	F / F	10	56,60
VSX141001500	1" 1/2"	F / F	10	67,87
VSX141002000	2"	F / F	2	103,09
VSX141002500	2" 1/2"	F / F	2	211,36
VSX141003000	3"	F / F	1	311,55

VSX 142

Valvole a sfera 3 pezzi INOX AISI 316L passaggio integrale / Stainless Steel ball valve full bore, 3 pieces

Pressione nominale / Nominal Pressure : 64 bar

Temperatura d'esercizio / Operating temperature : -10 ↔ +150 °C

Materiale / Material : INOX AISI 316



Cod.	Size			€ / Cad.
VSX142000500	1/2"	F / F	20	32,96
VSX142000700	3/4"	F / F	15	41,92
VSX142001000	1"	F / F	12	57,06
VSX142001200	1" 1/4"	F / F	5	91,05
VSX142001500	1" 1/2"	F / F	4	115,57
VSX142002000	2"	F / F	1	163,26

VSX 99F

Mini valvola INOX AISI 316L / Stainless Steel mini valve

Pressione nominale / Nominal Pressure : 63 bar

Temperatura d'esercizio / Operating temperature : -10 ↔ +150 °C

Materiale / Material : INOX AISI 316



Cod.	Size			€ / Cad.
VSX099F00200	1/4"	F / F	30	23,07
VSX099F00300	3/8"	F / F	30	22,66
VSX099F00500	1/2"	F / F	25	24,41

VSX 99M

Mini valvola INOX AISI 316L / Stainless Steel mini valve

Pressione nominale / Nominal Pressure : 63 bar

Temperatura d'esercizio / Operating temperature : -10 ↔ +150 °C

Materiale / Material : INOX AISI 316



Cod.	Size			€ / Cad.
VSX099M00200	1/4"	M / F	30	23,07
VSX099M00300	3/8"	M / F	30	22,66
VSX099M00500	1/2"	M / F	25	24,41

clicca il seguente link: www.assotherm.it o scannerizza il QR-Code per scaricare le schede tecniche dei prodotti





Valvole a sfera Serie GAS - MOP 5



Ball valves Serie GAS - MOP 5

VS 139

Valvola a sfera GAS passaggio integrale / Full bore GAS ball valve

Pressione nominale / Nominal Pressure : MOP 5

Temperatura d'esercizio / Operating temperature : -20 ↔ +60 °C

Materiale / Material : Ottone



Cod.	Size			€ / Cad.
VS0139005FGN	1/2"	F / F	160	8,40
VS0139007FGN	3/4"	F / F	120	11,30
VS0139010FGN	1"	F / F	60	16,80
VS0139012FGN	1" 1/4	F / F	48	29,35
VS0139015FGN	1" 1/2	F / F	24	45,21
VS0139020FGN	2"	F / F	8	70,95
VS0139025FGN	2" 1/2	F / F	1	225,00

VS 139P

Valvola a sfera GAS passaggio integrale / Full bore GAS ball valve

Pressione nominale / Nominal Pressure : MOP 5

Temperatura d'esercizio / Operating temperature : -20 ↔ +60 °C

Materiale / Material : Ottone



Cod.	Size			€ / Cad.
VS0139005PGN	1/2"	F / F	160	8,40
VS0139007PGN	3/4"	F / F	120	11,30
VS0139010PGN	1"	F / F	60	16,80

VS 139M

Valvola a sfera GAS passaggio integrale / Full bore GAS ball valve

Pressione nominale / Nominal Pressure : MOP 5

Temperatura d'esercizio / Operating temperature : -20 ↔ +60 °C

Materiale / Material : Ottone



Cod.	Size			€ / Cad.
VS0139M05FGN	1/2"	M / F	20	9,05
VS0139M07FGN	3/4"	M / F	15	12,00
VS0139M10FGN	1"	M / F	10	17,73

VS 139MP

Valvola a sfera GAS passaggio integrale / Full bore GAS ball valve

Pressione nominale / Nominal Pressure : MOP 5

Temperatura d'esercizio / Operating temperature : -20 ↔ +60 °C

Materiale / Material : Ottone



Cod.	Size			€ / Cad.
VS0139M05PGN	1/2"	M / F	25	9,05
VS0139M07PGN	3/4"	M / F	20	12,00
VS0139M10PGN	1"	M / F	15	17,73

clicca il seguente link: www.assotherm.it o scannerizza il QR-Code per scaricare le schede tecniche dei prodotti



VS 181

Valvola a sfera GAS passaggio integrale 90° / Full bore GAS ball valve 90°

Pressione nominale / Nominal Pressure : MOP 5

Temperatura d'esercizio / Operating temperature : -20 ↔ +60 °C

Materiale / Material : Ottone



Cod.	Size			€ / Cad.
VS0181005PGN	1/2"	M / F	25	11,00
VS0181007PGN	3/4"	M / F	20	14,10

VS 182

Valvola a sfera GAS passaggio integrale 90° / Full bore GAS ball valve 90°

Pressione nominale / Nominal Pressure : MOP 5

Temperatura d'esercizio / Operating temperature : -20 ↔ +60 °C

Materiale / Material : Ottone



Cod.	Size			€ / Cad.
VS0182005PGN	1/2"	M / M	25	11,00
VS0182007PGN	3/4"	M / M	20	14,10

VS 183

Valvola a sfera GAS passaggio integrale 90° dado girevole / Full bore GAS ball valve 90° turning nut

Pressione nominale / Nominal Pressure : MOP 5

Temperatura d'esercizio / Operating temperature : -20 ↔ +60 °C

Materiale / Material : Ottone



Cod.	Size			€ / Cad.
VS0183005PGN	1/2" - 1/2"	M / F	25	12,34
VS0183007PGN	1/2" - 3/4"	M / F	20	13,51

VS 184

Valvola a sfera GAS passaggio integrale 90° dado girevole / Full bore GAS ball valve 90° turning nut

Pressione nominale / Nominal Pressure : MOP 5

Temperatura d'esercizio / Operating temperature : -20 ↔ +60 °C

Materiale / Material : Ottone



Cod.	Size			€ / Cad.
VS0184005PGN	1/2" - 1/2"	F / F	25	12,34
VS0184007PGN	3/4" - 3/4"	F / F	20	18,22

clicca il seguente link: www.assotherm.it o scannerizza il QR-Code
per scaricare le schede tecniche dei prodotti





Valvole a sfera Serie "Gold"



Ball valves Serie "Gold"

VSB 141

Valvola a sfera passaggio integrale ISO 7 / Full bore ball valve ISO 7

Temperatura d'esercizio / Operating temperature : -20 ↔ +150 °C

Materiale / Material : Ottone



Cod.	Size		PN		€ / Cad.
VSB141005ANN	1/2"	F / F	50	20	8,04
VSB141007ANN	3/4"	F / F	40	15	11,37
VSB141010ANN	1"	F / F	40	10	17,55
VSB141012ANN	1" 1/4	F / F	30	5	31,01
VSB141015ANN	1" 1/2	F / F	30	5	46,06
VSB141020ANN	2"	F / F	25	2	69,60
VSB141025ANN	2" 1/2	F / F	18	2	198,00
VSB141030ANN	3"	F / F	16	1	286,00

VSB 141P

Valvola a sfera passaggio integrale ISO 7 / Full bore ball valve ISO 7

Temperatura d'esercizio / Operating temperature : -20 ↔ +150 °C

Materiale / Material : Ottone



Cod.	Size		PN		€ / Cad.
VSB141005PNN	1/2"	F / F	50	20	8,04
VSB141007PNN	3/4"	F / F	40	15	11,37
VSB141010PNN	1"	F / F	40	10	17,55

VSB 147

Valvola a sfera passaggio integrale ISO 7 / Full bore ball valve ISO 7

Temperatura d'esercizio / Operating temperature : -20 ↔ +150 °C

Materiale / Material : Ottone



Cod.	Size		PN		€ / Cad.
VSB147005ANN	1/2"	M / F	50	20	8,93
VSB147007ANN	3/4"	M / F	40	15	12,64
VSB147010ANN	1"	M / F	40	10	19,28
VSB147012ANN	1" 1/4	M / F	30	5	33,00
VSB147015ANN	1" 1/2	M / F	30	5	49,50
VSB147020ANN	2"	M / F	25	2	77,00

clicca il seguente link: www.assotherm.it o scannerizza il QR-Code per scaricare le schede tecniche dei prodotti



VS147P

Valvola a sfera passaggio integrale ISO 7 / Full bore ball valve ISO 7

Temperatura d'esercizio / Operating temperature : -20 ↔ +150 °C

Materiale / Material : Ottone



Cod.	Size		PN		€ / Cad.
VS147005PNN	1/2"	M / F	50	25	8,93
VS147007PNN	3/4"	M / F	40	20	12,64
VS147010PNN	1"	M / F	40	15	19,28

VS146B

Valvola a sfera passaggio integrale con bocchettone dritta / Full bore ball valve with nut and tail - straight pattern

Temperatura d'esercizio / Operating temperature : -20 ↔ +150 °C

Materiale / Material : Ottone



Cod.	Size		PN		€ / Cad.
VS146B05PNN	1/2"	M / F	50 bar	25	11,72
VS146B07PNN	3/4"	M / F	40 bar	20	16,64
VS146B10PNN	1"	M / F	40 bar	15	25,83

VS146A

Valvola a sfera passaggio integrale 90° con bocchettone a squadra / Full bore ball valve 90° with nut and tail - angle pattern

Temperatura d'esercizio / Operating temperature : -20 ↔ +150 °C

Materiale / Material : Ottone



Cod.	Size		PN		€ / Cad.
VS146A05PNN	1/2"	M / F	50 bar	25	14,57
VS146A07PNN	3/4"	M / F	40 bar	20	21,31
VS146A10PNN	1"	M / F	40 bar	15	34,71

clicca il seguente link: www.assotherm.it o scannerizza il QR-Code per scaricare le schede tecniche dei prodotti



VALVOLE MISCELATRICI E DEVIATRICI



Le valvole miscelatrici consentono la regolazione di un impianto di riscaldamento centralizzato attraverso la miscelazione dell'acqua in uscita dalla caldaia con quella di ritorno dall'impianto, allo scopo di ottenere la temperatura desiderata di mandata all'utenza. Possono essere motorizzate e abbinare a regolatori climatici per l'invio dell'acqua calda all'utenza, secondo l'effettivo fabbisogno termico necessario.



The mixing valves allow the regulation of a central heating system by mixing the water coming out of the boiler with that coming back from the system, in order to obtain the desired temperature of delivery to the user.

They can be motorized and combined with climate regulators to send hot water to the user, according to the actual thermal requirement.



Valvole miscelatrici e deviatrici



Mixing valves

VZ 150

Valvola miscelatrice e deviatrice ad otturatore 3 Vie PN 16 / 3-way mixing and diverter valve with shutter PN 16

Pressione nominale / Nominal Pressure : 16 bar

Temperatura d'esercizio / Operating temperature : +4 ↔ +150 °C

Materiale / Material : Ottone



Cod.	Size			€ / Cad.
VZ015000005	1/2"	F / F / F	1	213,75
VZ015000007	3/4"	F / F / F	1	213,75
VZ015000010	1"	F / F / F	1	231,40
VZ015000012	1" 1/4"	F / F / F	1	255,56
VZ015000015	1" 1/2"	F / F / F	1	278,79
VZ015000020	2"	F / F / F	1	440,49

VZ 151

Valvola miscelatrice e deviatrice ad otturatore 3 Vie PN 16 flangiata / 3-way flanged mixing and diverter valve with shutter PN 16

Pressione nominale / Nominal Pressure : 16 bar

Temperatura d'esercizio / Operating temperature : +4 ↔ +150 °C

Materiale / Material : Ghisa



Cod.	Size			€ / Cad.
VZ015100065	DN 65		1	1031,91
VZ015100080	DN 80		1	1265,29
VZ015100100	DN 100		1	2223,90

VZ 152

Attuatore on/off per valvole VZ 150 / On/off actuator for VZ 150 valves



Cod.	Size	Valve size		€ / Cad.
VZ0152000024	24 V	1/2" - 1"1/4	1	391,04
VZ0152000230	230 V	1/2" - 1"1/4	1	370,91
VZ0152A00024	24 V	1" 1/2 - 2"	1	494,85
VZ0152A00230	230 V	1" 1/2 - 2"	1	480,77

→ Disponibile regolazione modulante per versione 24 V su richiesta
→ Modulating regulation available for 24 V version on request

VZ 153

Attuatore on/off per valvole VZ 151 / On/off actuator for VZ 151 valves



Cod.	Size	Valve size		€ / Cad.
VZ0153A00024	24 V	DN 65 - DN100	1	494,85
VZ0153A00230	230 V	DN 65 - DN100	1	480,77

→ Disponibile regolazione modulante per versione 24 V su richiesta
→ Modulating regulation available for 24 V version on request

VZ 156

Valvola miscelatrice 3 vie, bocchettonata / 3 way mixing valve, nut and tail



Cod.	Size			€ / Cad.
VZ0156000007	3/4"		1	90,73
VZ0156000010	1"		1	95,82
<u>Solare Termico / Solar systems</u>				
VZ0156X00007	3/4"		1	94,35
VZ0156X00010	1"		1	105,00

clicca il seguente link: www.assotherm.it o scannerizza il QR-Code
per scaricare le schede tecniche dei prodotti



VALVOLE DI ZONA CON ATTUATORE

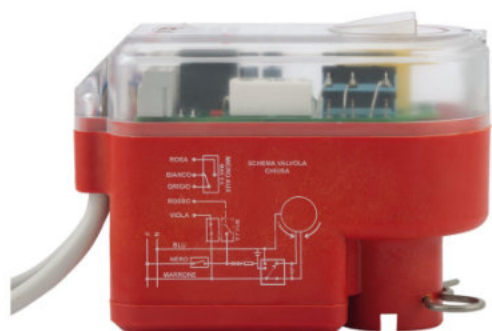

Le valvole di zona con attuatore sono particolarmente indicate per la regolazione di aree specifiche di un'abitazione o di un ambiente.

Consentono di regolare le diverse temperature di fabbisogno e dal comfort climatico richiesto dall'utente a seconda di differenti zone.



Zone valves with actuator are particularly suitable for the regulation of specific areas of a house or environment.

They allow to regulate the different temperatures of needs and the climatic comfort required by the user according to different zones.



Valvole con attuatore



Motorized valves

VZ 811

Valvola a sfera motorizzabile con bocchettone / Motorizable ball valve with nut and tail

Pressione nominale / Nominal Pressure : 16 bar

Temperatura d'esercizio / Operating temperature : -10 ↔ +100°C

Materiale / Material : Ottone



Cod.	Size				€ / Cad.
VZ0811000007	3/4"	M / F	2 Vie / 2 Ways	1	28,88
VZ0811000010	1"	M / F	2 Vie / 2 Ways	1	39,60
VZ0811000012	1"1/4	M / F	2 Vie / 2 Ways	1	49,95

VZ 812

Valvola a sfera motorizzabile con bocchettone / Motorizable ball valve with nut and tail

Pressione nominale / Nominal Pressure : 16 bar

Temperatura d'esercizio / Operating temperature : -10 ↔ +100°C

Materiale / Material : Ottone



Cod.	Size				€ / Cad.
VZ0812000007	3/4"	M / M	2 Vie / 2 Ways	1	35,30
VZ0812000010	1"	M / M	2 Vie / 2 Ways	1	50,94
VZ0812000012	1"1/4	M / M	2 Vie / 2 Ways	1	64,35

VZ 813

Valvola a sfera motorizzabile con bocchettone / Motorizable ball valve with nut and tail

Pressione nominale / Nominal Pressure : 16 bar

Temperatura d'esercizio / Operating temperature : -10 ↔ +100°C

Materiale / Material : Ottone



Cod.	Size				€ / Cad.
VZ0813000007	3/4"	M / M / M	3 Vie / 3 Ways	1	47,63
VZ0813000010	1"	M / M / M	3 Vie / 3 Ways	1	71,33

VZ 814

Valvola a sfera motorizzabile con bocchettone / Motorizable ball valve with nut and tail

Pressione nominale / Nominal Pressure : 16 bar

Temperatura d'esercizio / Operating temperature : -10 ↔ +100°C

Materiale / Material : Ottone



Cod.	Size				€ / Cad.
VZ0814000007	3/4"	M / M / M / M	4 Vie / 4 Ways	1	74,84
VZ0814000010	1"	M / M / M / M	4 Vie / 4 Ways	1	99,59

VZ 215

Servocomando elettrico valvole di zona / Electric actuator for zone valves



Cod.	Size				€ / Cad.
VZ0215000230	230 V			1	163,52
VZ0215000024	24 V			1	172,38

VZ 214

Servocomando elettrico valvole di zona (solo per VZ 811 - 812) / Electric actuator for zone valves (only for VZ 811 - 812)



Cod.	Size				€ / Cad.
VZ0214000230	230 V			1	111,79

clicca il seguente link: www.assotherm.it o scannerizza il QR-Code per scaricare le schede tecniche dei prodotti



VALVOLE INDUSTRIALI



Nella sezione valvole industriali, elenchiamo la gamma di prodotti legati alla intercettazione, regolazione e controllo di fluidi principalmente condotti da tubazioni di grosso diametro.

Questi prodotti, che sono generalmente a connessione flangiata, sono particolarmente indicati nella realizzazione di centrali termiche, frigorifere e idriche negli impianti centralizzati. Esempi di questa sezione sono le valvole a farfalla nella loro duplice possibilità di connessione tipo Wafer o Lug.



In the industrial valves section, we list the range of products related to the interception, regulation and control of fluids mainly conducted by large diameter pipes.

These products, which are generally flanged, are particularly suitable for the construction of thermal power plants, refrigerators and water in centralized systems. Examples of this section are butterfly valves in their dual connection possibilities such as Wafer or Lug.

**VI 235 T**

Valvola a farfalla Wafer / Wafer butterfly valve

Pressione nominale / Nominal Pressure: 16 bar

Temperatura d'esercizio / Operating temperature: -10 ↔ +120°C

Materiale / Material: Ghisa grigia / Cast iron



Cod.	Size			€ / Cad.
VI0235T04000	DN 40	PN 16	1	50,55
VI0235T05000	DN 50	PN 16	1	50,55
VI0235T06500	DN 65	PN 16	1	61,07
VI0235T08000	DN 80	PN 16	1	65,58
VI0235T10000	DN 100	PN 16	1	88,19
VI0235T12500	DN 125	PN 16	1	123,71
VI0235T15000	DN 150	PN 16	1	144,87
VI0235T20000	DN 200	PN 16	1	213,02
VI0235T25000	DN 250	PN 16	1	476,18
VI0235T30000	DN 300	PN 16	1	526,44

VI 255 T

Valvola a farfalla Lug / Lug butterfly valve

Pressione nominale / Nominal Pressure: 16 bar

Temperatura d'esercizio / Operating temperature: -10 ↔ +120°C

Materiale / Material: Ghisa grigia / Cast iron



Cod.	Size			€ / Cad.
VI0255T04000	DN 40	PN 16	1	64,72
VI0255T05000	DN 50	PN 16	1	65,43
VI0255T06500	DN 65	PN 16	1	77,59
VI0255T08000	DN 80	PN 16	1	88,96
VI0255T10000	DN 100	PN 16	1	130,57
VI0255T12500	DN 125	PN 16	1	173,61
VI0255T15000	DN 150	PN 16	1	196,22
VI0255T20000	DN 200	PN 16	1	320,70
VI0255T25000	DN 250	PN 16	1	520,30
VI0255T30000	DN 300	PN 16	1	687,70

VIK 235 T

Valvola a farfalla Wafer (asta e lente inox) / Wafer butterfly valve (stainless steel stem and lens)

Pressione nominale / Nominal Pressure: 16 bar

Temperatura d'esercizio / Operating temperature: -10 ↔ +120°C

Materiale / Material: Ghisa grigia / Cast iron



Cod.	Size			€ / Cad.
VIK235T04000	DN 40	PN 16	1	58,38
VIK235T05000	DN 50	PN 16	1	61,23
VIK235T06500	DN 65	PN 16	1	76,82
VIK235T08000	DN 80	PN 16	1	83,81
VIK235T10000	DN 100	PN 16	1	125,18
VIK235T12500	DN 125	PN 16	1	172,63
VIK235T15000	DN 150	PN 16	1	207,79
VIK235T20000	DN 200	PN 16	1	364,48
VIK235T25000	DN 250	PN 16	1	563,04
VIK235T30000	DN 300	PN 16	1	934,18

clicca il seguente link: www.assotherm.it o scannerizza il QR-Code per scaricare le schede tecniche dei prodotti



VIK 255 T

Valvola a farfalla Lug (asta e lente inox) / Lug butterfly valve (stainless steel stem and lens)

Pressione nominale / Nominal Pressure: 16 bar

Temperatura d'esercizio / Operating temperature: -10 ↔ +120°C

Materiale / Material: Ghisa grigia / Cast iron



Cod.	Size			€ / Cad.
VIK255T04000	DN 40	PN 16	1	79,52
VIK255T05000	DN 50	PN 16	1	79,52
VIK255T06500	DN 65	PN 16	1	94,82
VIK255T08000	DN 80	PN 16	1	112,34
VIK255T10000	DN 100	PN 16	1	164,90
VIK255T12500	DN 125	PN 16	1	225,39
VIK255T15000	DN 150	PN 16	1	294,97
VIK255T20000	DN 200	PN 16	1	467,80
VIK255T25000	DN 250	PN 16	1	851,40
VIK255T30000	DN 300	PN 16	1	1270,00

VI 355 T

Valvola a farfalla Lug per GAS (asta e lente inox) / Lug butterfly valve for GAS (stainless steel stem and lens)

Pressione nominale / Nominal Pressure: 16 bar

Temperatura d'esercizio / Operating temperature: -10 ↔ +120°C

Materiale / Material: Ghisa grigia / Cast iron



Cod.	Size			€ / Cad.
VI0355T04000	DN 40	PN 16	1	135,89
VI0355T05000	DN 50	PN 16	1	144,05
VI0355T06500	DN 65	PN 16	1	168,05
VI0355T08000	DN 80	PN 16	1	218,25
VI0355T10000	DN 100	PN 16	1	266,27
VI0355T12500	DN 125	PN 16	1	347,02
VI0355T15000	DN 150	PN 16	1	390,67
VI0355T20000	DN 200	PN 16	1	700,58

VI 44

Saracinesca in ghisa a cuneo gommato / Rubberized wedge cast iron gate valve

Pressione nominale / Nominal Pressure: 16 bar

Temperatura d'esercizio / Operating temperature: 0 ↔ +80°C

Materiale / Material: Ghisa grigia / Cast iron



Cod.	Size			€ / Cad.
VI0044004000	DN 40	PN 16	1	131,28
VI0044005000	DN 50	PN 16	1	143,00
VI0044006500	DN 65	PN 16	1	177,00
VI0044008000	DN 80	PN 16	1	219,35
VI0044010000	DN 100	PN 16	1	261,78
VI0044012500	DN 125	PN 16	1	385,00
VI0044015000	DN 150	PN 16	1	481,25
VI0044020000	DN 200	PN 16	1	766,12
VI0044025000	DN 250	PN 16	1	1125,00
VI0044030000	DN 300	PN 16	1	1679,90

clicca il seguente link: www.assotherm.it o scannerizza il QR-Code per scaricare le schede tecniche dei prodotti



VI 122

Valvola di ritegno a doppio battente (lente inox) / Dual plate check valve (stainless steel lens)

Pressione nominale / Nominal Pressure: 16 bar

Temperatura d'esercizio / Operating temperature: -10 ↔ +80°C

Materiale / Material: Ghisa grigia / Cast iron



Cod.	Size			€ / Cad.
VI0122004000	DN 40	PN 16	1	52,55
VI0122005000	DN 50	PN 16	1	55,60
VI0122006500	DN 65	PN 16	1	65,70
VI0122008000	DN 80	PN 16	1	85,90
VI0122010000	DN 100	PN 16	1	106,10
VI0122012500	DN 125	PN 16	1	143,80
VI0122015000	DN 150	PN 16	1	211,30
VI0122020000	DN 200	PN 16	1	374,29
VI0122025000	DN 250	PN 16	1	540,78
VI0122030000	DN 300	PN 16	1	730,70

VI 69F

Valvola di ritegno a palla, flangiata / Flanged ball check valve

Pressione nominale / Nominal Pressure: 16 bar

Temperatura d'esercizio / Operating temperature: -10 ↔ +80°C

Materiale / Material: Ghisa grigia / Cast iron



Cod.	Size			€ / Cad.
VI0069F05000	DN 50	PN 16	1	156,87
VI0069F06500	DN 65	PN 16	1	198,14
VI0069F08000	DN 80	PN 16	1	246,66
VI0069F10000	DN 100	PN 16	1	320,64
VI0069F12500	DN 125	PN 16	1	483,22
VI0069F15000	DN 150	PN 16	1	610,73
VI0069F20000	DN 200	PN 16	1	1292,88
VI0069F25000	DN 250	PN 16	1	2364,57
VI0069F30000	DN 300	PN 16	1	3008,56

VI 71

Valvola di ritegno clapet, flangiata / Flanged swing check valve

Pressione nominale / Nominal Pressure: 16 bar

Temperatura d'esercizio / Operating temperature: -10 ↔ +100°C

Materiale / Material: Ghisa grigia / Cast iron



Cod.	Size			€ / Cad.
VI0071005000	DN 50	PN 16	1	120,97
VI0071006500	DN 65	PN 16	1	184,92
VI0071008000	DN 80	PN 16	1	233,28
VI0071010000	DN 100	PN 16	1	281,65
VI0071012500	DN 125	PN 16	1	427,47
VI0071015000	DN 150	PN 16	1	607,47
VI0071020000	DN 200	PN 16	1	809,05
VI0071025000	DN 250	PN 16	1	1346,04
VI0071030000	DN 300	PN 16	1	1859,76

clicca il seguente link: www.assotherm.it o scannerizza il QR-Code per scaricare le schede tecniche dei prodotti



VI 69

Valvola di ritegno a palla, filettata / Threaded ball check valve

Pressione nominale / Nominal Pressure: 16 bar

Temperatura d'esercizio / Operating temperature: -10 ↔ +100°C

Materiale / Material: Ghisa grigia / Cast iron



Cod.	Size		📦	€ / Cad.
VI0069010000	1"	PN 16	1	67,86
VI0069012000	1" 1/4	PN 16	1	69,13
VI0069015000	1" 1/2	PN 16	1	83,81
VI0069020000	2"	PN 16	1	116,98
VI0069025000	2" 1/2	PN 16	1	167,96
VI0069030000	3"	PN 16	1	229,03

VI 200

Valvola di bilanciamento / Balancing valve

Pressione nominale / Nominal Pressure: 25 bar

Temperatura d'esercizio / Operating temperature: -10 ↔ +130°C

Materiale / Material: Bronzo / Bronze



Cod.	Size		📦	€ / Cad.
VI0200000150	1/2"	Threaded end	1	92,71
VI0200000200	3/4"	Threaded end	1	99,37
VI0200000250	1"	Threaded end	1	114,77
VI0200000320	1" 1/4	Threaded end	1	139,05
VI0200000400	1" 1/2	Threaded end	1	172,14
VI0200000500	2"	Threaded end	1	242,79
VI0200006500	DN 65	Flanged end	1	488,09
VI0200008000	DN 80	Flanged end	1	797,92
VI0200010000	DN 100	Flanged end	1	1196,87

→ Altre misura a richiesta / Other sizes on demand

VI 280

Filtro impurità ad Y in ghisa, flangiato / Flanged cast iron Y strainer

Pressione nominale / Nominal Pressure: 16 bar

Temperatura d'esercizio / Operating temperature: -10 ↔ +200°C

Materiale / Material: Ghisa grigia / Cast iron



Cod.	Size		📦	€ / Cad.
VI0280004000	DN 40	PN 16	1	63,95
VI0280005000	DN 50	PN 16	1	96,59
VI0280006500	DN 65	PN 16	1	139,30
VI0280008000	DN 80	PN 16	1	160,90
VI0280010000	DN 100	PN 16	1	210,30
VI0280012500	DN 125	PN 16	1	298,83
VI0280015000	DN 150	PN 16	1	418,17
VI0280020000	DN 200	PN 16	1	738,02
VI0280025000	DN 250	PN 16	1	1245,78
VI0280030000	DN 300	PN 16	1	1842,80

clicca il seguente link: www.assotherm.it o scannerizza il QR-Code per scaricare le schede tecniche dei prodotti



VI 10G

Giunto antivibrante compensatore in gomma, flangiato / Flanged expansion joint

Pressione nominale / Nominal Pressure : 16 bar

Temperatura d'esercizio / Operating temperature : -20 ↔ +115°C

Materiale / Material : EPDM



Cod.	Size		€ / Cad.
VI0010G04000	DN 40	1	47,83
VI0010G05000	DN 50	1	57,57
VI0010G06500	DN 65	1	72,37
VI0010G08000	DN 80	1	84,45
VI0010G10000	DN 100	1	96,82
VI0010G12500	DN 125	1	142,30
VI0010G15000	DN 150	1	181,27
VI0010G20000	DN 200	1	287,32
VI0010G25000	DN 250	1	412,87
VI0010G30000	DN 300	1	542,64

→ Prezzi netti a richiesta / Net prices on demand

VI 30G

Giunto antivibrante compensatore in gomma, filettato / Threaded expansion joint

Pressione nominale / Nominal Pressure : 16 bar

Temperatura d'esercizio / Operating temperature : -20 ↔ +115°C

Materiale / Material : EPDM



Cod.	Size		€ / Cad.
VI0030G07000	3/4"	1	29,39
VI0030G10000	1"	1	32,77
VI0030G12000	1" 1/4	1	42,70
VI0030G15000	1" 1/2	1	47,01
VI0030G20000	2"	1	59,74

VI 10Y

Compensatore assiale flangiato per alte temperature con convogliatore PN16 / Flanged axial compensator for high temperatures with conveyor



Cod.	Size		€ / Cad.
VI0010Y04000	DN 40	1	250,00
VI0010Y05000	DN 50	1	300,00
VI0010Y06500	DN 65	1	320,00
VI0010Y08000	DN 80	1	450,00
VI0010Y10000	DN 100	1	599,20
VI0010Y12500	DN 125	1	848,51
VI0010Y15000	DN 150	1	1007,94
VI0010Y20000	DN 200	1	1316,10

→ X versione a saldare indicare Cod. VI0010S.... / For welding version indicate Cod. VI0010S...

clicca il seguente link: www.assotherm.it o scannerizza il QR-Code per scaricare le schede tecniche dei prodotti



VI 2278

Flangia piana a saldare in acciaio al carbonio / Flat welding flange in carbon steel



Cod.	Size					€ / Cad.
VI2278002500	DN 25	PN 16	EN 1092-1	DIN 2576	1	
VI2278003200	DN 32	PN 16	EN 1092-1	DIN 2576	1	
VI2278004000	DN 40	PN 16	EN 1092-1	DIN 2576	1	
VI2278005000	DN 50	PN 16	EN 1092-1	DIN 2576	1	
VI2278006500	DN 65	PN 16	EN 1092-1	DIN 2576	1	
VI2278008000	DN 80	PN 16	EN 1092-1	DIN 2576	1	
VI2278010000	DN 100	PN 16	EN 1092-1	DIN 2576	1	
VI2278012500	DN 125	PN 16	EN 1092-1	DIN 2576	1	
VI2278015000	DN 150	PN 16	EN 1092-1	DIN 2576	1	
VI2278020000	DN 200	PN 16	EN 1092-1	DIN 2576	1	

→ Prezzi netti a richiesta / Net prices on demand

VI 2282

Flangia a collare a saldare in acciaio al carbonio / Collar flange to be welded in carbon steel



Cod.	Size					€ / Cad.
VI2282002500	DN 25	PN 16	EN 1092-1	DIN 2633	1	
VI2282003200	DN 32	PN 16	EN 1092-1	DIN 2633	1	
VI2282004000	DN 40	PN 16	EN 1092-1	DIN 2633	1	
VI2282005000	DN 50	PN 16	EN 1092-1	DIN 2633	1	
VI2282006500	DN 65	PN 16	EN 1092-1	DIN 2633	1	
VI2282008000	DN 80	PN 16	EN 1092-1	DIN 2633	1	
VI2282010000	DN 100	PN 16	EN 1092-1	DIN 2633	1	
VI2282012500	DN 125	PN 16	EN 1092-1	DIN 2633	1	
VI2282015000	DN 150	PN 16	EN 1092-1	DIN 2633	1	
VI2282020000	DN 200	PN 16	EN 1092-1	DIN 2633	1	

→ Prezzi netti a richiesta / Net prices on demand

VI 2290

Flangia filettata in acciaio al carbonio / Carbon steel threaded flange



Cod.	Size					€ / Cad.
VI2290001000	1"	PN 16	EN 1092-1	DIN 2566	1	
VI2290001200	1" 1/4	PN 16	EN 1092-1	DIN 2566	1	
VI2290001500	1" 1/2	PN 16	EN 1092-1	DIN 2566	1	
VI2290002000	2"	PN 16	EN 1092-1	DIN 2566	1	
VI2290002500	2" 1/2	PN 16	EN 1092-1	DIN 2566	1	
VI2290003000	3"	PN 16	EN 1092-1	DIN 2566	1	
VI2290004000	4"	PN 16	EN 1092-1	DIN 2566	1	
VI2290005000	5"	PN 16	EN 1092-1	DIN 2566	1	
VI2290006000	6"	PN 16	EN 1092-1	DIN 2566	1	
VI2290007000	8"	PN 16	EN 1092-1	DIN 2566	1	

→ Prezzi netti a richiesta / Net prices on demand

clicca il seguente link: www.assotherm.it o scannerizza il QR-Code
per scaricare le schede tecniche dei prodotti



VI 6093

Flangia cieca in acciaio al carbonio / Blind flange in carbon steel



Cod.	Size				€ / Cad.
VI6093002500	DN 25	EN 1092-1	DIN 2527	1	
VI6093003200	DN 32	EN 1092-1	DIN 2527	1	
VI6093004000	DN 40	EN 1092-1	DIN 2527	1	
VI6093005000	DN 50	EN 1092-1	DIN 2527	1	
VI6093006500	DN 65	EN 1092-1	DIN 2527	1	
VI6093008000	DN 80	EN 1092-1	DIN 2527	1	
VI6093010000	DN 100	EN 1092-1	DIN 2527	1	
VI6093012500	DN 125	EN 1092-1	DIN 2527	1	
VI6093015000	DN 150	EN 1092-1	DIN 2527	1	
VI6093020000	DN 200	EN 1092-1	DIN 2527	1	

→ Prezzi netti a richiesta / Net prices on demand

VI GF

Guarnizione in fibra sintetica per flange / Synthetic fiber gasket for flanges



Cod.	Size			€ / Cad.
VI00GF000025	DN 25			1,27
VI00GF000032	DN 32			1,65
VI00GF000040	DN 40			1,98
VI00GF000050	DN 50			2,70
VI00GF000065	DN 65			3,81
VI00GF000080	DN 80			5,46
VI00GF000100	DN 100			6,13
VI00GF000125	DN 125			8,84
VI00GF000150	DN 150			12,27
VI00GF000200	DN 200			20,47
VI00GF000250	DN 250			27,41

VI Bullone + Dado

Bullone e Dado per flange / Bolt and Nut for flanges



Cod.	Size			€ / Cad.
VI00V0016035	16x35			0,98
VI00V0016045	16x45			1,15
VI00V0016050	16x50			1,17
VI00V0016065	16x65			1,30
VI00V0016070	16x70			1,41
VI00V0016100	16x100			2,17
VI00V0016110	16x110			3,00
VI00V0020080	20x80			3,22
VI00V0020120	20x120			6,00
VI00D0000016	16			0,29
VI00D0000020	20			0,54

clicca il seguente link: www.assotherm.it o scannerizza il QR-Code per scaricare le schede tecniche dei prodotti



PRODOTTI PER STAFFAGGIO

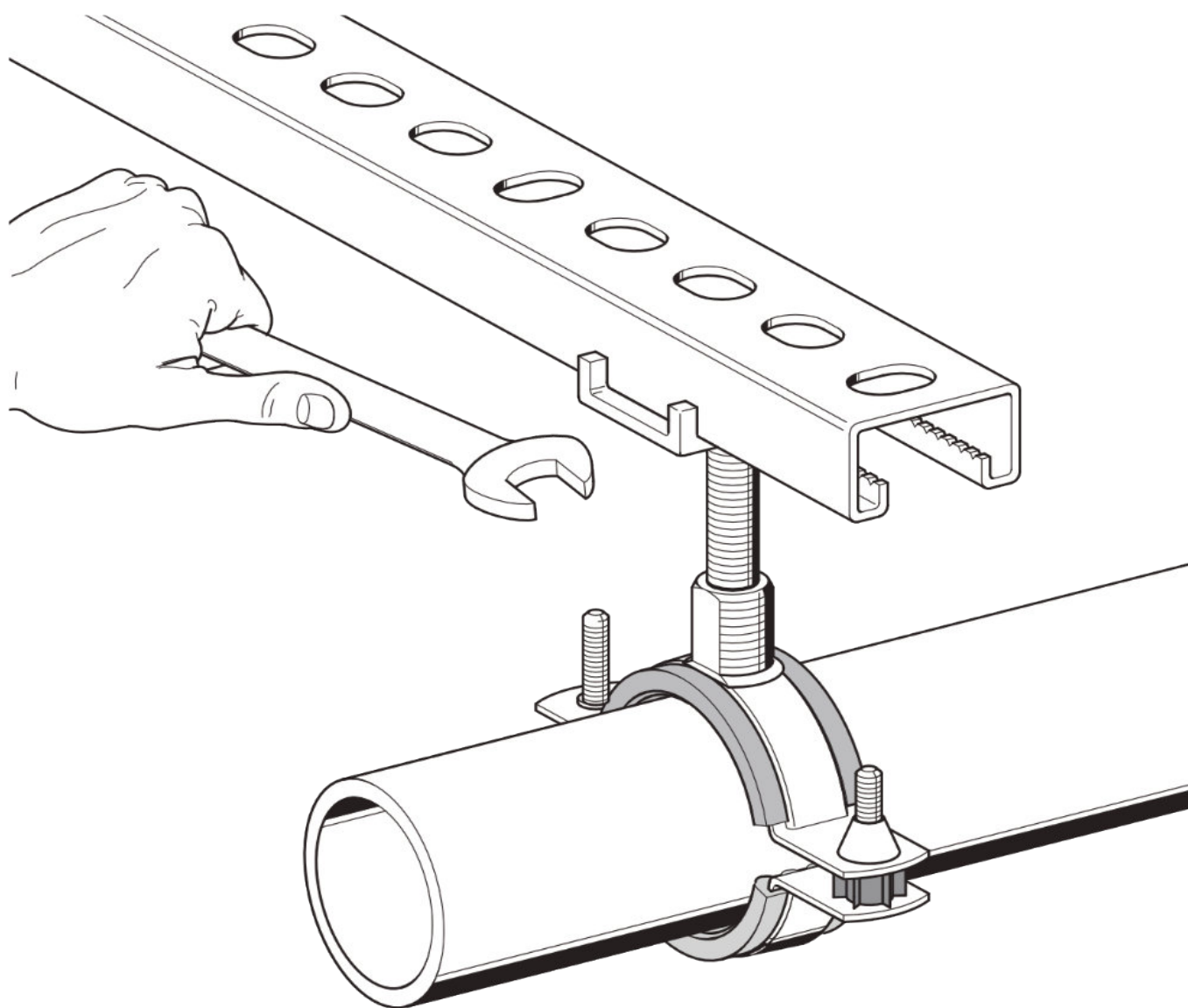

**VI 386S**

Kit collare fermatubo nudo pesante con tassello / Heavy naked hose clamp kit with plug



Cod.	Size		€ / Cad.
VI0386S00050	1/2	2	2,50
VI0386S00070	3/4	2	2,60
VI0386S00100	1"	2	2,80
VI0386S00120	1" 1/4	2	3,20
VI0386S00150	1" 1/2	2	3,30
VI0386S00200	2"	2	4,15
VI0386S00250	2" 1/2	2	5,00
VI0386S00300	3"	2	5,65
VI0386S00400	4"	2	6,50

VI 386G

Kit collare fermatubo gommato pesante con tassello / Heavy hose clamp kit with plug EPDM



Cod.	Size		€ / Cad.
VI0386G00050	1/2	2	2,80
VI0386G00070	3/4	2	2,90
VI0386G00100	1"	2	2,99
VI0386G00120	1" 1/4	2	3,20
VI0386G00150	1" 1/2	2	3,35
VI0386G00200	2"	2	4,00
VI0386G00250	2" 1/2	2	5,00
VI0386G00300	3"	2	6,20
VI0386G00400	4"	2	7,00

VI 388S

Collare fermatubo nudo pesante / Heavy naked hose clamp



Cod.	Size		€ / Cad.
VI0388S00050	1/2	1	1,75
VI0388S00070	3/4	1	1,90
VI0388S00100	1"	1	2,00
VI0388S00120	1" 1/4	1	2,40
VI0388S00150	1" 1/2	1	2,50
VI0388S00200	2"	1	3,30
VI0388S00250	2" 1/2	1	4,20
VI0388S00300	3"	1	4,90
VI0388S00400	4"	1	5,80

VI 388G

Collare fermatubo gommato pesante / Heavy hose clamp EPDM



Cod.	Size		€ / Cad.
VI0388G00050	1/2	1	1,98
VI0388G00070	3/4	1	2,04
VI0388G00100	1"	1	2,11
VI0388G00120	1" 1/4	1	2,26
VI0388G00150	1" 1/2	1	2,58
VI0388G00200	2"	1	3,06
VI0388G00250	2" 1/2	1	3,95
VI0388G00300	3"	1	4,64
VI0388G00400	4"	1	5,31

clicca il seguente link: www.assotherm.it o scannerizza il QR-Code
per scaricare le schede tecniche dei prodotti



ST BARRA

Profilo di fissaggio con barra / Galvanised agle fixing bar



Cod.	Size		€ / m
STBARRA30X15	30 x 15 - 2m	1	11,20
STBARRA41X21	41 x 21 - 3m	1	13,51
STBARRA41X41	41 x 41 - 3m	1	20,10

ST BARFIL

Barra filettata in acciaio zincato / Galvanized stud screw



Cod.	Size		€ / m
STBAR008100	M8 - 1m	1	2,10
STBAR010100	M10 - 1m	1	3,30

ST KIT MRD

Kit dado, rondella e vite testa a martello / Anchor kit screw and nut for fixing bar



Cod.	Size		€ / Cad.
STKITMRD000841-30	M8 x 41	10	2,10
STKITMRD000830-30	M8 x 30	10	1,20
STKITMRD001041-40	M10 x 41	10	3,00
STKITMRD001030-30	M10 x 30	10	2,80

ST MANI

Manicotto di giunzione per barra filettata / Connecting sleeve for threaded rod



Cod.	Size		€ / Cad.
STMANI00008	M8	10	1,15
STMANI00010	M10	10	1,35

clicca il seguente link: www.assotherm.it o scannerizza il QR-Code
per scaricare le schede tecniche dei prodotti



ST TAS

Tassello Espansione ottone / Wedge brass anchor W-ED



Cod.	Size		€ / Cad.
STTASS000008	M8	10	0,85
STTASS000010	M10	10	1,10

VI DADO

Dado zincato / Galvanized nut



Cod.	Size		€ / Cad.
VI00D000008	M8	50	0,08
VI00D000010	M10	50	0,14

ST PIAS

Piastra basamento in acciaio zincato 4 fori / Galvanized steel base plate 4 holes

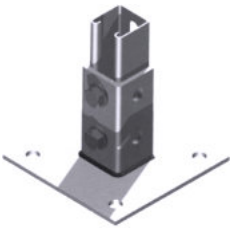

Cod.	Size	Ø Fori		€ / Cad.
STPIAS120120	120x120	13,5	1	17,70

ST PIAL

Staffa a L / L bracket



Cod.	Size	Ø Fori		€ / Cad.
STPIAL5050	50+50x40x5	13,5	1	1,90



Cod.	Size	Ø Fori		€ / Cad.
STPIAL10050	105+50x40x5	13,5	1	2,90



Cod.	Size	Ø Fori		€ / Cad.
STPIAL9898	90+105x40x5	13,5	1	3,90

clicca il seguente link: www.assotherm.it o scannerizza il QR-Code per scaricare le schede tecniche dei prodotti



COLLETTORI SANITARIA E RISCALDAMENTO



Nella sezione viene elencata la serie di collettori Assotherm destinati alla distribuzione sanitaria e riscaldamento.

La gamma si compone di collettori con regolazione a volantino, tramite intercettazione a sfera o semplici, con corpo stampato fino a 6 vie.

Tutti i collettori sono prodotti e testati secondo i più rigidi standard di qualità.



This section lists the Assotherm manifold series designed for sanitary distribution and heating systems. The range includes manifolds with wheel valve regulation, featuring either ball valve interception or simple models, with a cast body available in configurations up to 6 ways. All manifolds are manufactured and tested according to the highest quality standards.

**CL 98M**

Collettore per riscaldamento, interasse 35 mm, sede conica / Conical seat heating manifold, 35 mm center distance



Cod.	Size			€ / Cad.
CL0982M07050	3/4" x 1/2"	2 vie / 2 ways	10	9,00
CL0983M07050	3/4" x 1/2"	3 vie / 3 ways	10	12,50
CL0984M07050	3/4" x 1/2"	4 vie / 4 ways	10	15,90
CL0985M07050	3/4" x 1/2"	5 vie / 5 ways	10	22,00

CL 98MX

Collettore per riscaldamento, interasse 50 mm, sede piana / Flat seat heating manifold, 50 mm center distance



Cod.	Size			€ / Cad.
CL0982MX0705	3/4" x 1/2"	2 vie / 2 ways	10	8,28
CL0983MX0705	3/4" x 1/2"	3 vie / 3 ways	10	11,62
CL0984MX0705	3/4" x 1/2"	4 vie / 4 ways	10	15,50
CL0985MX0705	3/4" x 1/2"	5 vie / 5 ways	10	19,56
CL0986MX0705	3/4" x 1/2"	6 vie / 6 ways	10	23,90

CL 985F

Collettore femmina per riscaldamento, interasse 50mm / Female manifold for heating, center distance 50mm



Cod.	Size			€ / Cad.
CL985F070502	3/4" x 1/2"	2 vie / 2 ways	10	12,50
CL985F070503	3/4" x 1/2"	3 vie / 3 ways	10	19,00
CL985F070504	3/4" x 1/2"	4 vie / 4 ways	10	24,30
CL985F070505	3/4" x 1/2"	5 vie / 5 ways	10	29,50
CL985F070506	3/4" x 1/2"	6 vie / 6 ways	10	35,70

clicca il seguente link: www.assotherm.it o scannerizza il QR-Code
per scaricare le schede tecniche dei prodotti



CL 08R

Collettore di distribuzione sanitaria con valvola di chiusura, interasse 35 mm, sede conica / Sanitary distribution manifold with closing valve, 35 mm center distance, conical seat



Cod.	Size			€ / Cad.
CL082R0705N	3/4" x 1/2"	2 vie / 2 ways	10	15,95
CL082R1007N	1" x 3/4"	2 vie / 2 ways	10	26,00
CL083R0705N	3/4" x 1/2"	3 vie / 3 ways	10	22,40
CL083R1007N	1" x 3/4"	3 vie / 3 ways	10	35,50
CL084R0705N	3/4" x 1/2"	4 vie / 4 ways	10	30,91
CL084R1007N	1" x 3/4"	4 vie / 4 ways	10	46,00
CL085R0705N	3/4" x 1/2"	5 vie / 5 ways	10	38,40
CL086R0705N	3/4" x 1/2"	6 vie / 6 ways	10	43,50

CL 08X

Collettore di distribuzione sanitaria con valvole di chiusura monoblocco, interasse 50mm, sede piana, certificato ACS / Sanitary distribution manifold with monobloc shut-off valves, 50mm center distance, flat seat, ACS certified



Cod.	Size			€ / Cad.
CL082X07050	3/4" x 1/2"	2 vie / 2 ways	10	15,08
CL083X07050	3/4" x 1/2"	3 vie / 3 ways	10	21,21
CL084X07050	3/4" x 1/2"	4 vie / 4 ways	10	28,46
CL085X07050	3/4" x 1/2"	5 vie / 5 ways	10	35,03
CL086X07050	3/4" x 1/2"	6vie / 6 ways	10	41,87

CS 32

Cassetta in plastica per collettori / Plastic box for manifolds



Cod.	Internal size	External size		€ / Cad.
CS3200000320	320 x 280 x 80	330 x 290 x 88	10	26,09
CS3200000420	420 x 300 x 80	430 x 310 x 88	10	28,71
CS3200000520	520 x 320 x 80	530 x 330 x 88	10	30,91
CS3200000600	615 x 320 x 80	625 x 330 x 88	10	49,00

clicca il seguente link: www.assotherm.it o scannerizza il QR-Code per scaricare le schede tecniche dei prodotti



ADATTATORI VARI



Gli adattatori Assotherm sono lo strumento indispensabile per la corretta connessione delle tubazioni ai collettori o alle valvole per radiatore.

La Gamma comprende adattatori per diversi tipi di tubazione come: Tubo rame, Tubazioni multistrato, Tubazioni PEX.





Assotherm adapters are the indispensable tool for the correct connection of pipes to manifolds or radiator valves.

The Range includes adapters for different types of piping such as: Copper Pipe, Multilayer Piping, PEX Pipes.



DC 283

Adattatore per tubo multistrato / Multilayer pipe adapter

	Cod.	Size		€ / Cad.
	DC0283000516	1/2" x 16 x2	10	2,49



DC 283P

Adattatore per tubo PEX / PEX pipe adapter

	Cod.	Size		€ / Cad.
	DC0283P005165	1/2" x 16 x 1,5	10	2,49



DC 83P

Adattatore eurocono per tubo PEX / PEX pipe adapter eurokonus

	Cod.	Size		€ / Cad.
	DC0083P007165	3/4" x 16 x 1,5	10	3,40
	DC0083P00717	3/4" x 17 x 2	10	3,40
	DC0083P00720	3/4" x 20 x 2	10	4,90

DC 83M

Adattatore eurocono per tubo multistrato / Multilayer pipe adapter eurokonus

	Cod.	Size		€ / Cad.
	DC0083M00716	3/4" x 16 x 2	10	3,40
	DC0083M00720	3/4" x 20 x 2	10	3,90

clicca il seguente link: www.assotherm.it o scannerizza il QR-Code per scaricare le schede tecniche dei prodotti



MX 592

Raccordo con dado girevole per multistrato a stringere con sede piana / Fitting with swivel nut for multilayer tube with flat seat



Cod.	Size		€ / Cad.
MX0592005160	1/2" x 16 x 2	10	5,45
MX0592005200	1/2" x 20 x 2	10	6,68

MU 881C

Raccordo con dado girevole per multistrato a pressare sede conica / Fitting with swivel nut for multilayer tube conical seat



Cod.	Size		€ / Cad.
MU0881C05160	1/2" x 16 x 2	10	4,00
MU0881C05200	1/2" x 20 x 2	10	4,97

MU 881

Raccordo con dado girevole per multistrato a pressare sede piana / Fitting with swivel nut for multilayer tube flat seat



Cod.	Size		€ / Cad.
MU0881005160	1/2" x 16 x 2	10	3,97
MU0881005200	1/2" x 20 x 2	10	5,36

DC 100

Adattatore: sede conica → sede piana / Conical seat to flat seat adapter



Cod.	Size		€ / Cad.
DC001001600	1/2"	10	2,30

clicca il seguente link: www.assotherm.it o scannerizza il QR-Code per scaricare le schede tecniche dei prodotti



KIT PREASSEMBLATI PER ELEMENTI TERMINALI

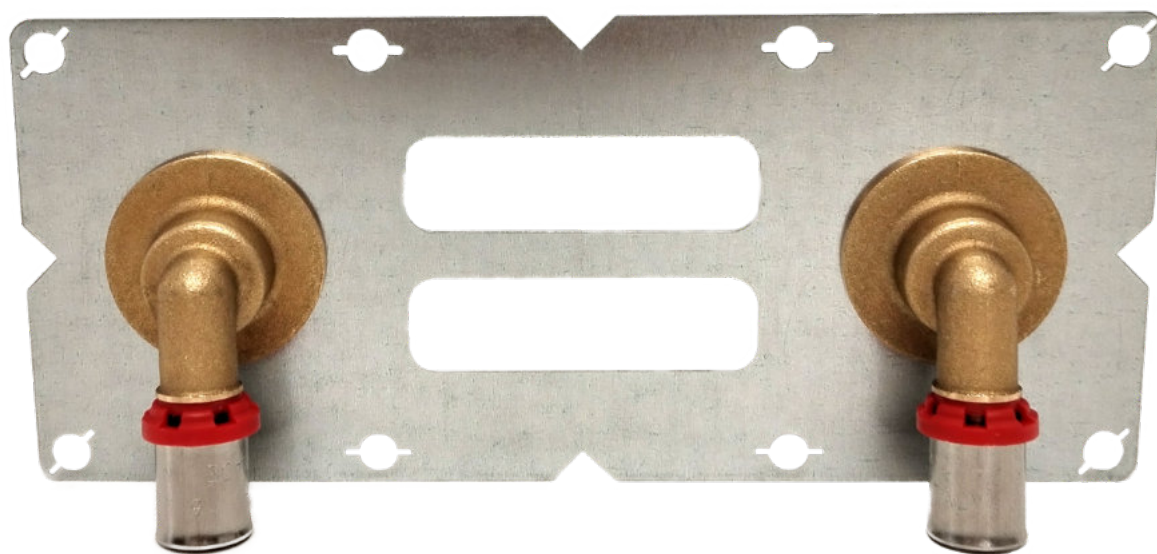



Kit preassemblati per elementi terminali



Preassembled kit for taps connection

→ Prezzi netti a richiesta / Net prices on demand

B1 863X

Distribuzione a 2 vie multistrato / Preassembled kit 2 ways for multilayer pipe, ready to install

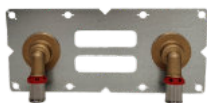

Cod.	Size		€ / Cad.
B1863X0516D	1/2" - 16	1	26,53
B1863X0520D	1/2" - 20	1	29,12

BP 863U

Distribuzione a 2 vie PEX / Preassembled kit 2 ways for PEX pipe, ready to install (press system)



Cod.	Size			€ / Cad.
BP863U0512D	1/2" - 12	Press system	1	27,04
BP863U0516D	1/2" - 16	Press system		26,32

BP 863P

Distribuzione a 2 vie PEX assiale / Preassembled kit 2 ways for PEX pipe, ready to install (axial system)



Cod.	Size			€ / Cad.
BP863P0512D	1/2" - 12	Axial system	1	26,17
BP863P0516D	1/2" - 16	Axial system	1	25,09

B1 864X

Distribuzione a 1 via multistrato / Preassembled kit 1 way for multilayer pipe, ready to install



Cod.	Size			€ / Cad.
B1864X0516D	1/2" - 16		1	14,72
B1864X0520D	1/2" - 20		1	16,02

BP 864U

Distribuzione a 1 via PEX / Preassembled kit 1 way for PEX pipe, ready to install (press system)



Cod.	Size			€ / Cad.
BP864U0512D	1/2" - 12	Press system	1	14,87
BP864U0516D	1/2" - 16	Press system	1	13,90

clicca il seguente link: www.assotherm.it o scannerizza il QR-Code per scaricare le schede tecniche dei prodotti



BP 864P

Distribuzione a 1 via PEX assiale / Preassembled kit 1 way for PEX pipe, ready to install (axial system)



Cod.	Size			€ / Cad.
BP864P0512D	1/2" - 12 Axial system		1	14,54
BP864P0516D	1/2" - 16 Axial system		1	14,00

B1 865X

Distribuzione a 2 vie multistrato (interasse 50mm) / Preassembled kit 2 ways for multilayer pipe (interaxe 50mm), ready to install



Cod.	Size			€ / Cad.
B1865X0516D	1/2" - 16		1	24,23

BP 865P

Distribuzione a 2 vie PEX assiale (interasse 50mm) / Preassembled kit 2 ways for PEX pipe (interaxe 50mm), ready to install (Axial system)



Cod.	Size			€ / Cad.
BP865P0512D	1/2" - 12 Axial system		1	26,82
BP865P0516D	1/2" - 16 Axial system		1	25,74

BP 865U

Distribuzione a 2 vie PEX (interasse 50mm) / Preassembled kit 2 way for PEX pipe (interaxe 50mm), ready to install (press system)



Cod.	Size			€ / Cad.
BP865U0512D	1/2" - 12 Press system		1	27,68
BP865U0516D	1/2" - 16 Press system		1	25,74

clicca il seguente link: www.assotherm.it o scannerizza il QR-Code per scaricare le schede tecniche dei prodotti



NEW ENTRY

RAPIDO

KIT CREAZIONE PUNTI ACQUA SANITARIA

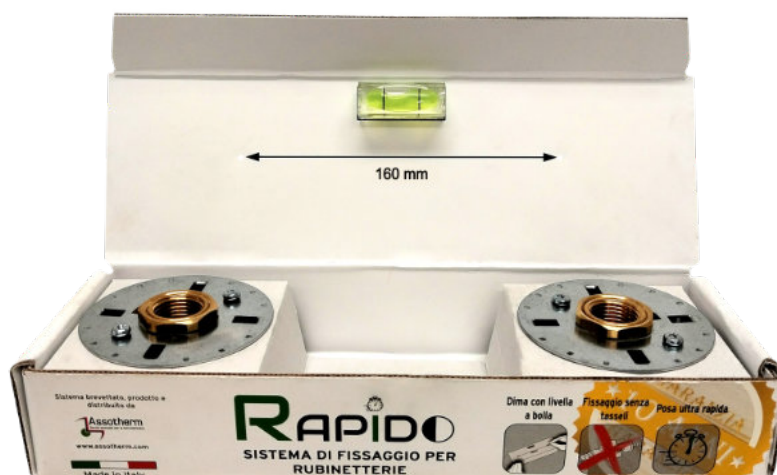

RAPIDO

Kit di creazione punti presa acqua sanitaria su cartongesso / Kit for creating domestic water connection points on plasterboard



Cod.	Size	Pipe		€ / Cad.
RAPIDOM1216	1/2" - 16 X 2	Multilayer Press	1	61,00
RAPIDOP1216	1/2" - 17 X 1,5	PEX Press	1	61,00

PRESS FITTING SYSTEMS

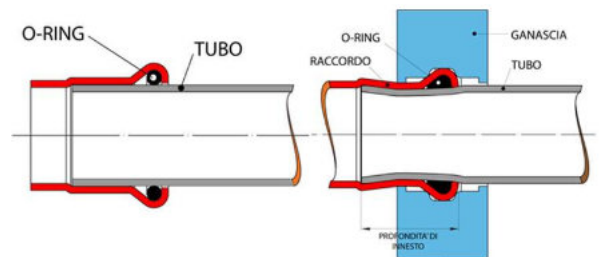

RACCORDI A PRESSARE PER TUBO MULTISTRATO



IPM Sistema a pressare per tubazioni Multistrato

Le tubazioni multistrato Assotherm del sistema IPM PRESS sono realizzate per estrusione di polietilene ad alta densità reticolato mediante processo chimico (PEXb) a cui viene sovrapposto un foglio di alluminio saldato testa a testa ed un successivo rivestimento di polietilene reticolato (PEXb). Tutti gli strati sono uniti fra loro per mezzo di collanti specifici, studiati per fornire al prodotto una struttura omogenea e resistente ad elevate temperature e pressioni. Le tubazioni possono essere fornite in verghe da 4 metri o rotoli dal diametro 16 al 32 mm.

I raccordi del sistema IPM PRESS Multistrato sono realizzati in ottone stampato conforme alle norme EN 12164-12165, utilizzando una lega CW 617N. La bussola di serraggio è prodotta in acciaio INOX 304 e la tenuta è garantita da guarnizioni in EPDM.

Il Sistema IPM PRESS Multistrato è concepito per utensili e ganasce di profilo "TH-H-U", secondo quanto indicato nel manuale tecnico, scaricabile dal sito www.assotherm.it



IPM Multilayer pipe press fittings system

The Assotherm multilayer pipes of IPM press system are produced by extrusion of high density polyethylene, cross-linked through chemical process (PEXb), to which is overlaid an aluminium foil welded head-to-head and a next covering of cross-linked polyethylene (PEXb).

All sections are linked one another with specific glues, designed to provide the product a uniform structure and to be high temperatures and pressures resistant.

Pipes can be provided both rods of 4m and rolls of DN16 32mm.

The fittings of IPM PRESS system multilayer are manufactured in printed brass, in accordance with rules EN 12164-12165, using an alloy CW 617N.

The clamping bush is manufactured in stainless steel 304 and the leakproofness is guaranteed by EPDM gaskets.

IPM PRESS Multilayer pipe is designed for "TH-H-U" Profile tools and pressing jaws, as indicated in the Technical Handbook downloadable on www.assotherm.it



Raccordi a pressione per tubo multistrato (IPM-MU)



Press fittings for multilayer pipe (IPM-MU)

Multiprofilo di pressatura: "TH-H-U" fino a 32mm, oltre: solo "TH" / "TH-H-U" up to 32mm, beyond: only "TH"

Materiale / Material : Ottone / Brass (CW617N, EN12165)

Temperatura / Temperature : -20 → +120 °C

Pressione nominale / Nominal pressure : 10 bar

MU 870

Manicotto a pressare / Press coupling



Cod.	Size		€ / Cad.
MU0870000160	16	10	3,70
MU0870000200	20	10	4,25
MU0870000260	26	10	6,60
MU0870000320	32	10	9,78
MU0870000400	40	5	26,96
MU0870000500	50	5	41,87
MU0870000630	63	1	66,19

MU 871

Raccordo a pressione uscita filetto maschio / Male press coupling



Cod.	Size		€ / Cad.
MU0871005160	1/2" - 16	10	2,55
MU0871005200	1/2" - 20	10	3,20
MU0871007160	3/4" - 16	10	4,60
MU0871007200	3/4" - 20	10	4,00
MU0871007260	3/4" - 26	5	5,00
MU0871010260	1" - 26	5	6,90
MU0871010320	1" - 32	5	8,11
MU0871012400	1" 1/4 - 40	1	24,61
MU0871015500	1" 1/2 - 50	1	35,65
MU0871020630	2" - 63	1	56,16

MU 880

Raccordo a pressione uscita filetto femmina / Female press coupling



Cod.	Size		€ / Cad.
MU0880005160	1/2" - 16	10	3,00
MU0880005200	1/2" - 20	10	3,75
MU0880007200	3/4" - 20	10	4,35
MU0880007260	3/4" - 26	5	4,81
MU0880010320	1" - 32	5	9,27
MU0880012400	1" 1/4 - 40	1	23,49
MU0880015500	1" 1/2 - 50	1	31,45
MU0880020630	2" - 63	1	53,64

MU 860

Curva a pressare femmina / Press equal elbow



Cod.	Size		€ / Cad.
MU0860000160	16	10	4,37
MU0860000200	20	10	5,85
MU0860000260	26	10	9,70
MU0860000320	32	10	13,05
MU0860000400	40	5	34,13
MU0860000500	50	5	56,78
MU0860000630	63	1	92,82

clicca il seguente link: www.assotherm.it o scannerizza il QR-Code per scaricare le schede tecniche dei prodotti



MU 861

Gomito a pressione uscita filetto maschio / Male press coupling



Cod.	Size		€ / Cad.
MU0861005160	1/2" - 16	10	4,00
MU0861005200	1/2" - 20	10	4,85
MU0861007200	3/4" - 20	10	5,85
MU0861007260	3/4" - 26	5	7,40
MU0861010320	1" - 32	5	12,99
MU0861012400	1" 1/4 - 40	1	31,50
MU0861015500	1" 1/2 - 50	1	57,67
MU0861020630	2" - 63	1	89,00

MU 862

Raccordo a pressione uscita filetto femmina / Female press coupling



Cod.	Size		€ / Cad.
MU0862005160	1/2" - 16	10	3,55
MU0862005200	1/2" - 20	10	4,70
MU0862007200	3/4" - 20	10	5,35
MU0862007260	3/4" - 26	5	7,60
MU0862010320	1" - 32	5	13,23
MU0862012400	1" 1/4 - 40	1	34,47
MU0862015500	1" 1/2 - 50	1	52,74

MU 850

Tee a pressione / Press equal Tee



Cod.	Size		€ / Cad.
MU0850000160	16	10	5,80
MU0850000200	20	10	7,80
MU0850000260	26	5	13,80
MU0850000320	32	5	21,55
MU0850000400	40	3	45,68
MU0850000500	50	2	75,50
MU0850000630	63	1	111,87

MU 851

Tee a pressione uscita filetto maschio / Male press Tee



Cod.	Size		€ / Cad.
MU0851005160	16 - 1/2" - 16	10	6,77
MU0851005200	20 - 1/2" - 20	10	8,36
MU0851007200	20 - 3/4" - 20	10	9,64
MU0851007260	26 - 3/4" - 26	5	12,95
MU0851010260	26 - 1" - 26	5	17,02
MU0851010320	32 - 1" - 32	3	18,93

MU 852

Tee a pressione uscita filetto femmina / Female press Tee



Cod.	Size		€ / Cad.
MU0852005160	16 - 1/2" - 16	10	6,29
MU0852005200	20 - 1/2" - 20	10	8,26
MU0852007200	20 - 3/4" - 20	10	9,44
MU0852007260	26 - 3/4" - 26	5	12,86
MU0852010260	26 - 1" - 26	5	20,76
MU0852010320	32 - 1" - 32	3	19,26
MU0852012400	40 - 1" 1/4 - 40	2	46,52
MU0852015500	50 - 1" 1/2 - 50	2	77,18
MU0852020630	63 - 2" - 63	1	112,87

clicca il seguente link: www.assotherm.it o scannerizza il QR-Code per scaricare le schede tecniche dei prodotti



MU 853

Tee a pressare ridotto / Reducing press Tee



Cod.	Size		€ / Cad.
MU085300CACO	20 - 16 - 20	10	8,27
MU085300CCAO	20 - 20 - 16	10	8,27
MU085300DADO	26 - 16 - 26	10	16,06
MU085300EAE0	32 - 16 - 32	10	23,46
MU085300CAA0	20 - 16 - 16	10	8,50
MU085300DCC0	26 - 20 - 20	10	16,22
MU085300DCD0	26 - 20 - 26	10	16,13
MU085300DDC0	26 - 26 - 20	10	16,27
MU085300EBE0	32 - 20 - 32	5	23,53
MU085300EDD0	32 - 26 - 26	5	24,87
MU085300EDE0	32 - 26 - 32	5	23,95
MU085300FDF0	40 - 26 - 40	5	40,13
MU085300FEF0	40 - 32 - 40	5	42,46
MU085300GDG0	50 - 26 - 50	5	67,26
MU085300GEG0	50 - 32 - 50	5	68,05
MU085300GFG0	50 - 40 - 50	5	71,08

MU 870R

Manicotto a pressare / Press coupling



Cod.	Size		€ / Cad.
MU0870R00BA0	16 - 20	10	4,25
MU0870R00DA0	16 - 26	10	5,90
MU0870R00EA0	16 - 32	10	7,27
MU0870R00DC0	20 - 26	10	6,17
MU0870R00EC0	20 - 32	10	8,94
MU0870R00ED0	26 - 32	10	9,92
MU0870R00FD0	26 - 40	5	25,33
MU0870R00FE0	32 - 40	5	25,33
MU0870R00GE0	32 - 50	5	38,05
MU0870R00GF0	40 - 50	5	38,46
MU0870R00HF0	40 - 63	2	55,88
MU0870R00HG0	50 - 63	2	60,47

MU 863

Curva con base a pressare filetto femmina / Wall plate press elbow



Cod.	Size		€ / Cad.
MU0863005160	1/2" - 16	10	5,40
MU0863005200	1/2" - 20	10	6,00
MU0863007260	3/4" - 26	10	9,85

MU 881

Raccordo dritto con dado girevole sede piana / Straight female coupling with tournable nut



Cod.	Size		€ / Cad.
MU0881005160	1/2" - 16	10	3,97
MU0881005200	1/2" - 20	10	5,36
MU0881007160	3/4" - 16	10	5,70
MU0881007200	3/4" - 20	10	6,46
MU0881010320	1" - 32	5	12,10

clicca il seguente link: www.assotherm.it o scannerizza il QR-Code per scaricare le schede tecniche dei prodotti



MU 882

Raccordo gomito con dado girevole sede piana / Female elbow with turnable nut



Cod.	Size		€ / Cad.
MU0882005160	1/2" - 16	10	11,17
MU0882005200	1/2" - 20	10	11,84
MU0882007160	3/4" - 16	10	12,48
MU0882007200	3/4" - 20	10	13,51
MU0882007260	3/4" - 26	10	14,00

MU 141

Valvola a sfera a pressare / ball valve press pattern



Cod.	Size		€ / Cad.
MU0141016FRO	16	10	6,80
MU0141020FRO	20	10	7,49
MU0141026FRO	26	10	10,75

MU 600

Valvola a sfera incasso a pressare / Built-in ball valve press pattern



Cod.	Size		€ / Cad.
MU060000016N	16	10	37,08
MU060000020N	20	10	45,75

MU 602

Valvola sfera a squadra con calotta, sede piana / Angle ball valve with rotating nut, flat seat



Cod.	Size		€ / Cad.
MU0602007200	3/4" - 20	10	19,67
MU0602010260	1" - 26	10	27,69

MU 120

Curva a pressare 45° / Press elbow 45°



Cod.	Size		€ / Cad.
MU0120000400	40	10	49,38
MU0120000500	50	10	72,92
MU0120000630	63	10	110,53

clicca il seguente link: www.assotherm.it o scannerizza il QR-Code per scaricare le schede tecniche dei prodotti



RACCORDI A STRINGERE PER TUBO MULTISTRATO



Raccordi a stringere per tubo multistrato

Compression fittings for multilayer pipe

Materiale / Material : Ottone / Brass (CW617N UNI EN 12165)

Temperatura d'esercizio / Operating temperature : 0 ↔ +95 °C

Pressione nominale / Nominal pressure: PN 10

MX 550

Tee a stringere / Compression Tee



Cod.	Size		€ / Cad.
MX0550000160	16	10	7,90
MX0550000200	20	10	11,96
MX0550000260	26	5	21,54
MX0550000320	32	5	33,22

MX 553

Tee ridotto a stringere / Compression reducing Tee



Cod.	Size		€ / Cad.
MX055300AACO	16 - 16 - 20	10	11,71
MX055300ACAO	16 - 20 - 16	10	11,68
MX055300ACCO	16 - 20 - 20	10	12,45
MX055300CACO	20 - 16 - 20	10	12,11
MX055300DADO	26 - 16 - 26	5	19,30
MX055300DCCO	26 - 20 - 20	5	20,80
MX055300DCDO	26 - 20 - 26	5	21,04
MX055300EDDO	32 - 26 - 26	5	37,00
MX055300EDEO	32 - 26 - 32	5	32,96

MX 551

Tee uscita filetto maschio a stringere / Compression male reducing Tee



Cod.	Size		€ / Cad.
MX0551005160	16 - 1/2" - 16	10	6,79
MX0551005200	20 - 1/2" - 20	10	10,21
MX0551007200	20 - 3/4" - 20	10	10,99
MX0551007260	26 - 3/4" - 26	10	16,16
MX0551010260	26 - 1" - 26	10	19,59
MX0551010320	32 - 1" - 32	10	28,54

MX 552

Tee uscita filetto femmina a stringere / Compression female reducing Tee



Cod.	Size		€ / Cad.
MX0552005160	16 - 1/2" - 16	10	6,82
MX0552005200	20 - 1/2" - 20	10	10,49
MX0552007200	20 - 3/4" - 20	10	10,79
MX0552007260	26 - 3/4" - 26	10	15,87
MX0552010260	26 - 1" - 26	10	24,00
MX0552010320	32 - 1" - 32	10	28,01

MX 560

Curva a stringere / Compression elbow



Cod.	Size		€ / Cad.
MX0560000160	16 x 2	10	5,72
MX0560000200	20 x 2	10	8,42
MX0560000260	26 x 3	5	14,14
MX0560000320	32 x 3	5	23,28

clicca il seguente link: www.assotherm.it o scannerizza il QR-Code per scaricare le schede tecniche dei prodotti



MX 561

Curva uscita filetto maschio a stringere / Male compression elbow



Cod.	Size		€ / Cad.
MX0561005160	1/2" - 16	10	4,12
MX0561005200	1/2" - 20	10	5,99
MX0561007200	3/4" - 20	10	6,52
MX0561007260	3/4" - 26	5	9,60
MX0561010260	1" - 26	5	11,47
MX0561010320	1" - 32	5	16,67

MX 562

Curva uscita filetto femmina a stringere / Female compression elbow



Cod.	Size		€ / Cad.
MX0562005160	1/2" - 16	10	4,35
MX0562005200	1/2" - 20	10	6,02
MX0562007200	3/4" - 20	10	6,63
MX0562007260	3/4" - 26	5	10,90
MX0562010260	1" - 26	5	12,14
MX0562010320	1" - 32	5	16,54

MX 563

Gomito con base, uscita femmina a stringere / Wall plate compression elbow



Cod.	Size		€ / Cad.
MX0563005160	1/2" - 16	10	5,74
MX0563005200	1/2" - 20	10	8,44
MX0563007200	3/4" - 20	10	8,38

MX 570

Manicotto a stringere / Compression coupling



Cod.	Size		€ / Cad.
MX0570000160	16	10	4,97
MX0570000200	20	10	8,16
MX0570000260	26	5	12,50
MX0570000320	32	5	22,74

MX 571

Raccordo dritto uscita filetto maschio a stringere / Male compression coupling



Cod.	Size		€ / Cad.
MX0571003160	3/8" - 16	10	2,94
MX0571005160	1/2" - 16	10	2,93
MX0571005200	1/2" - 20	10	4,67
MX0571007160	3/4" - 16	10	4,32
MX0571007200	3/4" - 20	10	4,93
MX0571007260	3/4" - 26	10	7,97
MX0571010260	1" - 26	10	10,69
MX0571010320	1" - 32	10	15,22

MX 580

Raccordo dritto uscita filetto femmina a stringere / Female compression coupling



Cod.	Size		€ / Cad.
MX0580003160	3/8" - 16	10	3,50
MX0580005160	1/2" - 16	10	3,25
MX0580005200	1/2" - 20	10	4,72
MX0580007160	3/4" - 16	10	4,42
MX0580007200	3/4" - 20	10	4,99
MX0580007260	3/4" - 26	10	7,74
MX0580010260	1" - 26	10	10,75
MX0580010320	1" - 32	10	14,30

clicca il seguente link: www.assotherm.it o scannerizza il QR-Code per scaricare le schede tecniche dei prodotti



RACCORDI A PRESSARE IN ACCIAIO AL CARBONIO



IPC-RAC Sistema in acciaio al carbonio galvanizzato

Le tubazioni del sistema IPC PRESS ACCIAIO AL CARBONIO, sono realizzate mediante utilizzo di lega di acciaio al carbonio, ricoperta da strato di elettrozincatura di protezione contro fenomeni di corrosione, con materia N° 1.0038 secondo normativa DIN EN 10305, superficie liscia e saldatura longitudinale secondo DIN EN 10305-3.

Le tubazioni sono fornite in barre da 6 metri.

Le raccorderie del sistema IPC PRESS ACCIAIO AL CARBONIO, sono realizzate mediante acciaio E 195 (Rst 34-2), materia N° 1.0034 secondo i requisiti della normativa DIN 10305-3, forniti dalla dimensione 15 mm sino a 108 mm.

Il raccordo è fornito di strato di elettro galvanizzazione a protezione dei fenomeni corrosivi, tenuto conto delle condizioni di esercizio dell'installazione.

Tutti i raccordi sono marcati con logo del produttore.

Il Sistema IPC PRESS ACCIAIO AL CARBONIO è concepito per utensili e ganasce di profilo "M", e per gli usi indicati nel manuale tecnico, scaricabile dal sito www.assotherm.it



IPC-RAC Press fittings system galvanized carbon steel

The PRESS CARBON STEEL PIPE is a longitudinally seam welded, thin-walled precision steel pipe commensurate to DIN EN 10305-3.

The pipe is externally and internally electrogalvanized and the weld seam is smoothed in order to guarantee a flawless leak-proof surface.

The PRESS CARBON STEEL PIPE are supplied in 6-meter long rods.

IPC PRESS CARBON STEEL pressfittings are made of unalloyed steel E 195 (Rst 34-2) factory material no.1.0034 according to DIN EN 10305-3 can be supplied in dimensions 15 - 108mm.

The electrogalvanization protects the fitting against external corrosion, by considering the standard use of the installation.

The fittings are permanently marked with the manufacturer's logo and the "electroplated" label.

IPC PRESS CARBON STEEL is designed for "M" Profile tools and pressing jaws and proper use as indicated in the Technical Handbook downloadable on www.assotherm.it



Raccordi a pressare in acciaio al carbonio (IPC-RAC)



Press fittings carbon steel (IPC-RAC)

Profilo di pressatura: "M" / Press profile: "M"

RAC 270

Manicotto con battuta a pressare / Press coupling



Cod.	Size		€ / Cad.
RAC270000150	15	10	1,71
RAC270000180	18	10	1,74
RAC270000220	22	10	1,96
RAC270000280	28	10	2,40
RAC270000350	35	4	4,23
RAC270000420	42	2	5,65
RAC270000540	54	2	6,76
RAC270000760	76	1	27,55
RAC270000890	89	1	35,04
RAC270001080	108	1	46,85

RAC 271

Raccordo con battuta a pressare, uscita filetto maschio / Male press coupling



Cod.	Size		€ / Cad.
RAC271005150	1/2" - 15	10	5,05
RAC271005180	1/2" - 18	10	5,15
RAC271005220	1/2" - 22	10	6,10
RAC271007180	3/4" - 18	10	6,00
RAC271007220	3/4" - 22	10	5,95
RAC271007280	3/4" - 28	10	9,50
RAC271010220	1" - 22	10	8,65
RAC271010280	1" - 28	10	8,10
RAC271010350	1" - 35	4	13,95
RAC271012350	1" 1/4 - 35	4	13,70
RAC271015420	1" 1/2 - 42	4	15,95
RAC271020540	2" - 54	2	25,19
RAC271025760	2" 1/2 - 76	1	94,61
RAC271030890	3" - 89	1	150,50
RAC271040108	4" - 108	1	130,00

RAC 280

Raccordo con battuta a pressare, uscita filetto femmina / Female press coupling



Cod.	Size		€ / Cad.
RAC280005150	1/2" - 15	10	5,18
RAC280005180	1/2" - 18	10	5,25
RAC280005220	1/2" - 22	10	6,50
RAC280007180	3/4" - 18	10	6,35
RAC280007220	3/4" - 22	10	6,35
RAC280007280	3/4" - 28	10	12,09
RAC280010220	1" - 22	10	10,35
RAC280010280	1" - 28	10	8,45
RAC280010350	1" - 35	4	14,30
RAC280012350	1" 1/4 - 35	4	13,75
RAC280015420	1" 1/2 - 42	4	24,00
RAC280020540	2" - 54	2	28,50

clicca il seguente link: www.assotherm.it o scannerizza il QR-Code per scaricare le schede tecniche dei prodotti



RAC 90

Curva a pressare femmina / Female press Elbow



Cod.	Size		€ / Cad.
RAC090000150	15	10	2,43
RAC090000180	18	10	2,76
RAC090000220	22	10	2,97
RAC090000280	28	10	4,06
RAC090000350	35	4	9,35
RAC090000420	42	2	14,68
RAC090000540	54	2	18,96
RAC090000760	76	1	47,45
RAC090000890	89	1	67,35
RAC090001080	108	1	91,51

RAC 92

Curva a pressare maschio/femmina / Male/female press Elbow



Cod.	Size		€ / Cad.
RAC092000150	15	10	2,63
RAC092000180	18	10	2,88
RAC092000220	22	10	3,15
RAC092000280	28	10	3,89
RAC092000350	35	4	9,35
RAC092000420	42	2	14,68
RAC092000540	54	2	18,96
RAC092000760	76	1	43,67
RAC092000890	89	1	67,49
RAC092001080	108	1	97,75

RAC 120

Curva a pressare a 45° femmina / 45° female press elbow



Cod.	Size		€ / Cad.
RAC120000150	15	10	2,62
RAC120000180	18	10	2,77
RAC120000220	22	10	3,03
RAC120000280	28	10	4,06
RAC120000350	35	4	8,78
RAC120000420	42	2	11,03
RAC120000540	54	2	15,57
RAC120000760	76	1	46,35
RAC120000890	89	1	67,03
RAC120001080	108	1	89,43

RAC 121

Curva a pressare a 45° maschio/femmina / 45° male/female press elbow



Cod.	Size		€ / Cad.
RAC121000150	15	10	2,84
RAC121000180	18	10	2,95
RAC121000220	22	10	3,20
RAC121000280	28	10	4,29
RAC121000350	35	4	8,88
RAC121000420	42	2	11,07
RAC121000540	54	2	14,87
RAC121000760	76	1	45,75
RAC121000890	89	1	67,03
RAC121001080	108	1	89,43

clicca il seguente link: www.assotherm.it o scannerizza il QR-Code
per scaricare le schede tecniche dei prodotti



RAC 261

Curva uscita filetto maschio / Male press elbow



Cod.	Size		€ / Cad.
RAC261005150	1/2" - 15	10	8,01
RAC261005180	1/2" - 18	10	8,37
RAC261007220	3/4" - 22	10	10,66
RAC261010280	1" - 28	4	13,13

RAC 262

Curva uscita filetto femmina / Female press elbow



Cod.	Size		€ / Cad.
RAC262005150	1/2" - 15	10	10,54
RAC262005180	1/2" - 18	10	11,26
RAC262007220	3/4" - 22	10	13,55
RAC262010280	1" - 28	4	15,59

RAC 130

Tee a pressare / Press Tee



Cod.	Size		€ / Cad.
RAC130000150	15	10	4,72
RAC130000180	18	10	4,92
RAC130000220	22	10	5,41
RAC130000280	28	4	6,89
RAC130000350	35	2	11,11
RAC130000420	42	2	16,59
RAC130000540	54	1	19,95
RAC130000760	76	1	91,40
RAC130000890	89	1	109,10
RAC130001080	108	1	140,39

RAC 130F

Tee a pressare uscita filetto femmina / Female press Tee



Cod.	Size		€ / Cad.
RAC130F05150	15 - 1/2" - 15	10	6,36
RAC130F05180	18 - 1/2" - 18	10	6,59
RAC130F05220	22 - 1/2" - 22	10	6,93
RAC130F05280	28 - 1/2" - 28	10	7,98
RAC130F05350	35 - 1/2" - 35	4	11,75
RAC130F05420	42 - 1/2" - 42	2	17,42
RAC130F05540	54 - 1/2" - 54	1	20,36
RAC130F07220	22 - 3/4" - 22	4	8,39
RAC130F07280	28 - 3/4" - 28	4	9,19
RAC130F07350	35 - 3/4" - 35	2	14,68
RAC130F07420	42 - 3/4" - 42	1	20,36
RAC130F07540	54 - 3/4" - 54	1	22,02
RAC130F07760	76 - 3/4" - 76	1	75,45
RAC130F07890	89 - 3/4" - 89	1	105,98
RAC130F07108	108 - 3/4" - 108	1	125,84

clicca il seguente link: www.assotherm.it o scannerizza il QR-Code per scaricare le schede tecniche dei prodotti



RAC 1312

Tee a pressare doppia riduzione - Double reducing press Tee



Cod.	Size		€ / Cad.
RAC131221515	22 - 15 - 15	10	8,54
RAC131222215	22 - 22 - 15	10	8,40
RAC131282222	28 - 22 - 22	5	11,35
RAC131282822	28 - 28 - 22	5	11,47

RAC 131

Tee a pressare ridotto / Reducing press Tee



Cod.	Size		€ / Cad.
RAC131015180	18 - 15 - 18	10	5,45
RAC131015220	22 - 15 - 22	10	5,00
RAC131018220	22 - 18 - 22	10	5,20
RAC131015280	28 - 15 - 28	10	6,62
RAC131018280	28 - 18 - 28	10	6,85
RAC131022280	28 - 22 - 28	10	7,18
RAC131015350	35 - 15 - 35	4	10,50
RAC131018350	35 - 18 - 35	4	10,86
RAC131022350	35 - 22 - 35	4	11,27
RAC131028350	35 - 28 - 35	4	11,52
RAC131022420	42 - 22 - 42	4	14,73
RAC131028420	42 - 28 - 42	4	15,32
RAC131035420	42 - 35 - 42	1	15,56
RAC131022540	54 - 22 - 54	1	17,22
RAC131028540	54 - 28 - 54	1	17,63
RAC131035540	54 - 35 - 54	1	18,16
RAC131042540	54 - 42 - 54	1	19,23
RAC131022760	76 - 22 - 76	1	61,20
RAC131028760	76 - 28 - 76	1	66,77
RAC131035760	76 - 35 - 76	1	68,99
RAC131042760	76 - 42 - 76	1	69,53
RAC131054760	76 - 54 - 76	1	70,11
RAC131054890	89 - 54 - 89	1	99,04
RAC131076890	89 - 76 - 89	1	102,85
RAC131761080	108 - 76 - 108	1	123,45
RAC131891080	108 - 89 - 108	1	124,18

RAC 246

Manicotto ridotto M-F / Reducing press coupling M-F



Cod.	Size		€ / Cad.
RAC246015180	15 - 18	10	1,82
RAC246015220	15 - 22	10	2,25
RAC246015280	15 - 28	10	2,95
RAC246018220	18 - 22	10	2,35
RAC246018280	18 - 28	10	3,34
RAC246022280	22 - 28	10	2,66
RAC246022350	22 - 35	10	4,69
RAC246022420	22 - 42	4	8,78
RAC246022540	22 - 54	4	18,05
RAC246028350	28 - 35	4	3,23
RAC246028420	28 - 42	4	8,94
RAC246028540	28 - 54	2	18,21
RAC246035420	35 - 42	4	6,42
RAC246035540	35 - 54	2	14,68
RAC246042540	42 - 54	2	8,78
RAC246042760	42 - 76	1	37,05
RAC246054760	54 - 76	1	35,60
RAC246054890	54 - 89	1	38,94
RAC246076890	76 - 89	1	46,48
RAC246076108	76 - 108	1	54,52
RAC246089108	89 - 108	1	62,31

clicca il seguente link: www.assotherm.it o scannerizza il QR-Code
per scaricare le schede tecniche dei prodotti



RAC 85

Scavalca tubo / By pass



Cod.	Size		€ / Cad.
RAC085000150	15	10	3,21
RAC085000180	18	10	3,50
RAC085000220	22	10	3,78
RAC085000280	28	4	4,81

RAC 85L

Scavalca tubo lungo / Long by pass



Cod.	Size		€ / Cad.
RAC085L00150	15	10	3,04
RAC085L00180	18	10	3,22
RAC085L00220	22	10	3,45
RAC085L00280	28	4	4,03

RAC 290

Tappo a pressione femmina / Press female cap



Cod.	Size		€ / Cad.
RAC2900000150	15	1	3,17
RAC2900000180	18	1	3,39
RAC2900000220	22	1	3,74
RAC2900000280	28	1	5,94
RAC2900000350	35	1	7,52
RAC2900000420	42	1	12,67
RAC2900000540	54	1	13,16

RAX EPDM

O-ring in EPDM nero / Black EPDM O-ring

Temperatura d'esercizio / Operating temperature: -10°C - +110°C

Utilizzo: acqua potabile, antincendio, acqua piovana, acqua trattata, riscaldamento, circuiti chiusi, acqua demineralizzata, vapore.

Use: drinking water, fire prevention, rainwater, treated water, heating, closed circuits, demineralised water, steam.



Cod.	Size		€ / Cad.
RAXOREPDM015	15	1	0,74
RAXOREPDM018	18	1	0,78
RAXOREPDM022	22	1	0,80
RAXOREPDM028	28	1	0,86
RAXOREPDM035	35	1	1,39
RAXOREPDM042	42	1	1,44
RAXOREPDM054	54	1	1,55
RAXOREPDM076	76	1	3,09
RAXOREPDM089	89	1	3,73
RAXOREPDM0108	108	1	6,40

RAX FPM

O-ring in FPM verde / Green FPM O-ring

Temperatura d'esercizio / Operating temperature: -30°C - +180°C

Utilizzo: acqua potabile, acqua trattata, riscaldamento, aria compressa, oli minerali, grassi, impianti solari.

Use: drinking water, treated water, heating, compressed air, mineral oils, greases, solar systems.



Cod.	Size		€ / Cad.
RAXORFPMV015	15	1	1,07
RAXORFPMV018	18	1	1,23
RAXORFPMV022	22	1	1,44
RAXORFPMV028	28	1	1,60
RAXORFPMV035	35	1	1,92
RAXORFPMV042	42	1	2,67
RAXORFPMV054	54	1	3,35
RAXORFPMV076	76	1	6,18
RAXORFPMV089	89	1	9,32
RAXORFPMV0108	108	1	21,32

clicca il seguente link: www.assotherm.it o scannerizza il QR-Code per scaricare le schede tecniche dei prodotti



RACCORDI A PRESSARE IN ACCIAIO INOX 316L



IPI-RAX Sistema in acciaio inossidabile AISI 316L

IPI INOX PRESS AISI 316L è un tubo a superficie sottile e liscia saldato longitudinalmente.

La materia prima che compone questo tubo è in alta lega, austenitica, non soggetta a ruggine, Cr-Ni-Mo acciaio N° 1.4404 (AISI 316L) secondo normativa EN 10088. Le tubazioni sono conformi ai requisiti della normativa EN 10312, PrEN 10217 e DVGW GW 541. Le superfici interne di questo tipo di tubazione sono galvanicamente nude e pertanto libere da materiali di tipo corrosivo. Le tubazioni PRESS INOX AISI 316L sono fornite in barre da 6 metri.

I raccordi del sistema IPI INOX PRESS sono realizzati mediante utilizzo di materia prima in alta lega, austenitica, non soggetta a ruggine, acciaio N° 1.4404 (AISI 316L) secondo normativa EN 10088.

I diametri sono studiati secondo i requisiti della tubazione e secondo i requisiti della normativa EN10312 e/o DVGW GW 541. I raccordi sono forniti con la guarnizione EPDM standard già installata nella propria sede.

Il Sistema IPI INOX PRESS è concepito per utensili e ganasce di profilo "M", e secondo gli usi indicati nel manuale tecnico, scaricabile dal sito www.assotherm.it



IPI- RAX Press fittings system stainless steel AISI 316L

The IPI PRESS INOX AISI 316L pipe is a longitudinally seam welded, thin-walled pipe.

The pipe material is a high-alloy, austenitic, non-rusting Cr-Ni-Mo steel with material no. 1.4404 (AISI 316 L) according to EN 10088.

These installation pipes correspond to the requirements of EN 10312, PrEN 10217 and DVGW GW 541.

The internal and external surfaces of these pipes are metallically bare and therefore free of tarnish and corrosive materials. This has been verified and certified by the DVGW. PRESS INOX PIPE is supplied in 6-meter long rods.

The IPI INOX PRESS fittings are manufactured by high-alloy, austenitic, non-rusting Cr-Ni-Mo steel with material no. 1.4404 (AISI 316L) according to EN 10088. The diameters of these pressfittings are engineered for pipes according to the requirements of EN 10312 and/or DVGW GW 541 and are delivered with factory installed standard EPDM gaskets.

IPI INOX PRESS is designed for "M" Profile tools and pressing jaws and use, as indicated in the Technical Handbook downloadable on www.assotherm.it

 **Raccordi a pressare in acciaio INOX AISI 316L (IPI-RAX)**

 **Press fittings stainless steel AISI 316L (IPI-RAX)**

Profilo di pressatura: "M" / Press profile: "M"

RAX 270

Manicotto con battuta a pressare / Press coupling



Cod.	Size		€ / Cad.
RAX270000150	15	25	3,71
RAX270000180	18	25	3,86
RAX270000220	22	25	4,42
RAX270000280	28	10	5,33
RAX270000350	35	10	7,04
RAX270000420	42	10	9,50
RAX270000540	54	5	11,96
RAX270000760	76	1	55,42
RAX270000890	89	1	69,84
RAX270001080	108	1	89,79

RAX 271

Raccordo con battuta a pressare, uscita filetto maschio / Male press coupling



Cod.	Size		€ / Cad.
RAX271005150	1/2" - 15	10	7,83
RAX271005180	1/2" - 18	10	8,19
RAX271005220	1/2" - 22	10	9,40
RAX271007150	3/4" - 15	10	8,92
RAX271007180	3/4" - 18	10	8,27
RAX271007220	3/4" - 22	10	9,32
RAX271007280	3/4" - 28	10	12,20
RAX271010220	1" - 22	10	11,25
RAX271010280	1" - 28	10	11,83
RAX271010350	1" - 35	10	16,72
RAX271012350	1" 1/4 - 35	10	17,01
RAX271015420	1" 1/2 - 42	5	24,76
RAX271020540	2" - 54	1	33,77
RAX271025760	2" 1/2 - 76	1	146,90
RAX271030890	3" - 89	1	216,66

RAX 280

Raccordo con battuta a pressare, uscita filetto femmina / Female press coupling



Cod.	Size		€ / Cad.
RAX280005150	1/2" - 15	10	7,39
RAX280005180	1/2" - 18	10	8,39
RAX280005220	1/2" - 22	10	9,10
RAX280007180	3/4" - 18	10	9,15
RAX280007220	3/4" - 22	10	10,37
RAX280007280	3/4" - 28	10	11,93
RAX280010220	1" - 22	10	12,17
RAX280010280	1" - 28	10	15,57
RAX280010350	1" - 35	10	16,94
RAX280012350	1" 1/4 - 35	10	17,59
RAX280015420	1" 1/2 - 42	5	27,01
RAX280020540	2" - 54	1	39,26

clicca il seguente link: www.assotherm.it o scannerizza il QR-Code per scaricare le schede tecniche dei prodotti



RAX 270L

Manicotto di riparazione / Long press coupling



Cod.	Size		€ / Cad.
RAX270L00150	15	10	10,71
RAX270L00180	18	10	10,82
RAX270L00220	22	10	11,00
RAX270L00280	28	10	13,16
RAX270L00350	35	10	16,50
RAX270L00420	42	4	17,95
RAX270L00540	54	4	19,55
RAX270L00760	76	1	126,54
RAX270L00890	89	1	144,81
RAX270L01080	108	1	164,18

RAX 90

Curva a pressare femmina / Female press Elbow



Cod.	Size		€ / Cad.
RAX090000150	15	25	5,42
RAX090000180	18	25	5,86
RAX090000220	22	15	7,20
RAX090000280	28	5	9,11
RAX090000350	35	5	14,58
RAX090000420	42	5	26,89
RAX090000540	54	3	35,64
RAX090000760	76	1	90,90
RAX090000890	89	1	130,00
RAX090001080	108	1	170,00

RAX 92

Curva a pressare maschio/femmina / Male/female press Elbow



Cod.	Size		€ / Cad.
RAX092000150	15	25	5,55
RAX092000180	18	25	6,39
RAX092000220	22	15	7,48
RAX092000280	28	5	9,48
RAX092000350	35	5	14,73
RAX092000420	42	5	25,67
RAX092000540	54	3	35,79
RAX092000760	76	1	89,79
RAX092000890	89	1	130,00
RAX092001080	108	1	170,00

RAX 120

Curva a pressare a 45° femmina / 45° female press elbow



Cod.	Size		€ / Cad.
RAX120000150	15	25	6,79
RAX120000180	18	25	7,20
RAX120000220	22	25	8,37
RAX120000280	28	10	10,24
RAX120000350	35	10	12,81
RAX120000420	42	10	20,68
RAX120000540	54	5	26,89
RAX120000760	76	1	88,70
RAX120000890	89	1	116,21
RAX120001080	108	1	155,64

clicca il seguente link: www.assotherm.it o scannerizza il QR-Code per scaricare le schede tecniche dei prodotti



RAX 121

Curva a pressare a 45° maschio/femmina / 45° male/female press elbow



Cod.	Size		€ / Cad.
RAX121000150	15	10	6,63
RAX121000180	18	10	7,12
RAX121000220	22	10	8,26
RAX121000280	28	10	10,24
RAX121000350	35	4	12,81
RAX121000420	42	2	20,68
RAX121000540	54	2	26,55
RAX121000760	76	1	87,58
RAX121000890	89	1	116,21
RAX121001080	108	1	155,64

RAX 261

Curva uscita filetto maschio / Male press elbow



Cod.	Size		€ / Cad.
RAX261005150	1/2" - 15	15	11,32
RAX261005180	1/2" - 18	15	13,91
RAX261007220	3/4" - 22	10	16,24
RAX261010280	1" - 28	10	21,67
RAX261012350	1" 1/4 - 35	10	29,13
RAX261015420	1" 1/2 - 42	10	47,62
RAX261020540	2" - 54	5	56,63

RAX 262

Curva uscita filetto femmina / Female press elbow



Cod.	Size		€ / Cad.
RAX262005150	1/2" - 15	15	12,17
RAX262005180	1/2" - 18	15	14,47
RAX262007220	3/4" - 22	15	17,02
RAX262010280	1" - 28	10	22,23
RAX262012350	1" 1/4 - 35	10	31,86

RAX 290

Tappo a pressare femmina / Press female cap

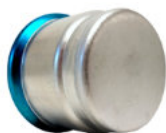

Cod.	Size		€ / Cad.
RAX290000150	15	1	8,92
RAX290000180	18	1	9,70
RAX290000220	22	1	11,09
RAX290000280	28	1	12,95
RAX290000350	35	1	15,54
RAX290000420	42	1	20,22
RAX290000540	54	1	24,37
RAX290000760	76	1	42,12
RAX290000890	89	1	53,21
RAX290001080	108	1	65,45

clicca il seguente link: www.assotherm.it o scannerizza il QR-Code per scaricare le schede tecniche dei prodotti



RAX 227

Flangia con manicotto a pressione / Straight coupling with flange



Cod.	Size		€ / Cad.
RAX227000220	22	1	50,99
RAX227000280	28	1	64,76
RAX227000350	35	1	89,79
RAX227000420	42	1	112,53
RAX227000540	54	1	131,44
RAX227000760	76	1	180,71
RAX227000890	89	1	203,99
RAX227001080	108	1	241,68

RAX 130

Tee a pressione / Press Tee



Cod.	Size		€ / Cad.
RAX130000150	15	10	9,67
RAX130000180	18	10	10,27
RAX130000220	22	10	11,70
RAX130000280	28	4	13,90
RAX130000350	35	4	18,90
RAX130000420	42	2	22,27
RAX130000540	54	2	30,32
RAX130000760	76	1	143,65
RAX130000890	89	1	162,97
RAX130001080	108	1	209,54

RAX 130F

Tee a pressione, uscita filetto femmina / Female press Tee



Cod.	Size		€ / Cad.
RAX130F05150	15 - 1/2" - 15	10	10,68
RAX130F05180	18 - 1/2" - 18	10	11,56
RAX130F05220	22 - 1/2" - 22	10	11,56
RAX130F05280	28 - 1/2" - 28	10	13,60
RAX130F05350	35 - 1/2" - 35	5	16,51
RAX130F05420	42 - 1/2" - 42	5	20,65
RAX130F05540	54 - 1/2" - 54	3	24,34
RAX130F07220	22 - 3/4" - 22	10	13,06
RAX130F07280	28 - 3/4" - 28	10	16,64
RAX130F07350	35 - 3/4" - 35	5	20,82
RAX130F07420	42 - 3/4" - 42	5	23,74
RAX130F07540	54 - 3/4" - 54	3	29,49
RAX130F07760	76 - 3/4" - 76	3	131,44
RAX130F07890	89 - 3/4" - 89	1	140,80
RAX130F20540	54 - 2" - 54	1	57,02
RAX130F20760	76 - 2" - 76	1	170,00
RAX130F20890	89 - 2" - 89	1	180,00
RAX130F20108	108 - 2" - 108	1	220,00

clicca il seguente link: www.assotherm.it o scannerizza il QR-Code
per scaricare le schede tecniche dei prodotti



RAX 246

Manicotto ridotto F-M / Reducing press coupling F-M



Cod.	Size		€ / Cad.
RAX246015220	15 - 22	25	4,82
RAX246015280	15 - 28	10	5,89
RAX246018220	18 - 22	10	4,97
RAX246018280	18 - 28	10	5,99
RAX246022280	22 - 28	10	6,05
RAX246022350	22 - 35	10	8,04
RAX246022420	22 - 42	10	16,53
RAX246028350	28 - 35	10	8,44
RAX246028420	28 - 42	10	16,97
RAX246028540	28 - 54	10	23,67
RAX246035420	35 - 42	10	10,03
RAX246035540	35 - 54	10	19,64
RAX246042540	42 - 54	10	12,31
RAX246054760	54 - 76	1	54,33
RAX246054890	54 - 89	1	63,00
RAX246076890	76 - 89	1	85,96
RAX246054108	54 - 108	1	89,02
RAX246076108	76 - 108	1	94,85
RAX246089108	89 - 108	1	97,55

RAX 240

Manicotto ridotto F-F / Reducing press coupling



Cod.	Size		€ / Cad.
RAX240015180	15 - 18	25	8,30
RAX240015220	15 - 22	10	8,72
RAX240015350	15 - 35	10	11,62
RAX240015420	15 - 42	10	14,38
RAX240015540	15 - 54	10	17,45
RAX240018280	18 - 28	10	10,10
RAX240018420	18 - 42	10	14,50
RAX240018540	18 - 54	10	17,65
RAX240022280	22 - 28	10	10,45
RAX240022350	22 - 35	10	12,43
RAX240022540	22 - 54	10	18,17
RAX240028350	28 - 35	10	13,00
RAX240028420	28 - 42	10	15,35
RAX240028540	28 - 54	1	18,50
RAX240035420	35 - 42	1	16,60
RAX240035540	35 - 54	1	19,60
RAX240042540	42 - 54	1	21,50

clicca il seguente link: www.assotherm.it o scannerizza il QR-Code
per scaricare le schede tecniche dei prodotti



RAX 131

Tee a pressare ridotto / Reducing press Tee



Cod.	Size		€ / Cad.
RAX131015180	18 - 15 - 18	10	10,13
RAX131015220	22 - 15 - 22	10	10,95
RAX131015280	28 - 15 - 28	10	11,93
RAX131018220	22 - 18 - 22	10	11,93
RAX131018280	28 - 18 - 28	10	12,48
RAX131022280	28 - 22 - 28	10	13,33
RAX131022350	35 - 22 - 35	4	15,77
RAX131022420	42 - 22 - 42	4	21,38
RAX131022540	54 - 22 - 54	4	26,45
RAX131028350	35 - 28 - 35	4	16,60
RAX131028420	42 - 28 - 42	4	22,16
RAX131028540	54 - 28 - 54	4	26,71
RAX131035420	42 - 35 - 42	1	24,38
RAX131035540	54 - 35 - 54	1	27,61
RAX131035760	76 - 35 - 76	1	135,26
RAX131042540	54 - 42 - 54	1	30,21
RAX131042760	76 - 42 - 76	1	148,56
RAX131054760	76 - 54 - 76	1	161,87
RAX131054890	89 - 54 - 89	1	175,16
RAX131054108	108 - 54 - 108	1	202,88
RAX131076890	89 - 76 - 89	1	177,39
RAX131076108	108 - 76 - 108	1	215,00
RAX131089108	108 - 89 - 108	1	220,25

RAX 340

Raccordo dritto 3pz filetto femmina / 3 pieces female coupling



Cod.	Size		€ / Cad.
RAX340007220	3/4" - 22	5	38,55
RAX340010280	1" - 28	4	40,00
RAX340012350	1" 1/4 - 35	4	55,00
RAX340015420	1" 1/2 - 42	2	70,00
RAX340020540	2" - 54	1	130,00

RAX 341

Raccordo dritto 3pz filetto maschio / 3 pieces male coupling



Cod.	Size		€ / Cad.
RAX341005150	1/2" - 15	10	23,65
RAX341005180	1/2" - 18	10	26,00
RAX341007220	3/4" - 22	5	27,70
RAX341010280	1" - 28	4	46,60
RAX341012350	1" 1/4 - 35	4	59,40
RAX341015420	1" 1/2 - 42	2	74,70
RAX341020540	2" - 54	1	118,70

clicca il seguente link: www.assotherm.it o scannerizza il QR-Code per scaricare le schede tecniche dei prodotti



RACCORDI A PRESSARE IN ACCIAIO INOX 304L



IPI-RAZ Sistema in acciaio inossidabile AISI 304L

IPI INOX PRESS AISI 304L è un tubo a superficie sottile e liscia saldato longitudinalmente.

La materia prima che compone questo tubo è in alta lega, austenitica, non soggetta a ruggine, Cr-Ni-Mo acciaio N° 1.4307 (AISI 304L) secondo normativa EN 10088-2. Le tubazioni sono conformi ai requisiti della normativa EN 10312 e PrEN.

Le superfici interne di questo tipo di tubazione sono galvanicamente nude e pertanto libere da materiali di tipo corrosivo.

Le tubazioni PRESS INOX AISI 304L sono fornite in barre da 6 metri.

I raccordi del sistema IPI INOX PRESS sono realizzati mediante utilizzo di materia prima in alta lega, austenitica, non soggetta a ruggine, acciaio N° 1.4307 (AISI 304L) secondo normativa EN 10088-2.

I diametri sono studiati secondo i requisiti della tubazione e secondo i requisiti della normativa EN10312. I raccordi sono forniti con la guarnizione EPDM standard già installata nella propria sede.

Il Sistema IPI INOX PRESS è concepito per utensili e ganasce di profilo "M", e secondo gli usi indicati nel manuale tecnico, scaricabile dal sito www.assotherm.it



IPI- RAZ Press fittings system stainless steel AISI 304L

The IPI PRESS INOX AISI 304L pipe is a longitudinally seam welded, thin-walled pipe.

The pipe material is a high-alloy, austenitic, non-rusting Cr-Ni-Mo steel with material no. 1.4307 (AISI 304L) according to EN 10088-2.

These installation pipes correspond to the requirements of EN 10312, PrEN.

The internal and external surfaces of these pipes are metallicly bare and therefore free of tarnish and corrosive materials.

PRESS INOX PIPE is supplied in 6-meter long rods.

The IPI INOX PRESS fittings are manufactured by high-alloy, austenitic, non-rusting Cr-Ni-Mo steel with material no. 1.4307 (AISI 304L) according to EN 10088-2. The diameters of these pressfittings are engineered for pipes according to the requirements of EN 10312. and are delivered with factory installed standard EPDM gaskets.

IPI INOX PRESS is designed for "M" Profile tools and pressing jaws and use, as indicated in the Technical Handbook downloadable on www.assotherm.it

Raccordi a pressare in acciaio INOX AISI 304L (IPI-RAZ)

Press fittings stainless steel AISI 304L (IPI-RAZ)

Profilo di pressatura: "M" / Press profile: "M"

RAZ 270

Manicotto con battuta a pressare / Press coupling



Cod.	Size		€ / Cad.
RAZ270000150	15	25	2,85
RAZ270000180	18	25	2,87
RAZ270000220	22	25	3,60
RAZ270000280	28	10	4,50
RAZ270000350	35	10	5,39
RAZ270000420	42	10	7,00
RAZ270000540	54	5	8,85
RAZ270000760	76	1	37,44
RAZ270000890	89	1	45,98
RAZ270000108	108	1	65,32

RAZ 271

Raccordo con battuta a pressare, uscita filetto maschio / Male press coupling



Cod.	Size		€ / Cad.
RAZ271005150	1/2" - 15	10	6,55
RAZ271005180	1/2" - 18	10	7,43
RAZ271005220	1/2" - 22	10	8,05
RAZ271007150	3/4" - 15	10	8,20
RAZ271007180	3/4" - 18	10	8,97
RAZ271007220	3/4" - 22	10	7,50
RAZ271007280	3/4" - 28	10	11,36
RAZ271010220	1" - 22	10	14,52
RAZ271010280	1" - 28	10	9,35
RAZ271010350	1" - 35	10	13,62
RAZ271012350	1" 1/4 - 35	10	13,03
RAZ271012420	1" 1/4 - 42	5	24,59
RAZ271015420	1" 1/2 - 42	5	19,95
RAZ271015540	1" 1/2 - 54	5	34,02
RAZ271020540	2" - 54	1	26,90
RAZ271025760	2" 1/2 - 76	1	67,37
RAZ271030890	3" - 89	1	73,90

RAZ 280

Raccordo con battuta a pressare, uscita filetto femmina / Female press coupling



Cod.	Size		€ / Cad.
RAZ280005150	1/2" - 15	10	6,40
RAZ280005180	1/2" - 18	10	7,26
RAZ280005220	1/2" - 22	10	7,89
RAZ280007150	3/4" - 15	10	8,06
RAZ280007180	3/4" - 18	10	8,79
RAZ280007220	3/4" - 22	10	8,60
RAZ280007280	3/4" - 28	10	11,13
RAZ280010220	1" - 22	10	12,50
RAZ280010280	1" - 28	10	13,00
RAZ280010350	1" - 35	10	13,36
RAZ280012350	1" 1/4 - 35	10	16,00
RAZ280012420	1" 1/4 - 42	10	24,08
RAZ280015420	1" 1/2 - 42	5	23,25
RAZ280015540	1" 1/2 - 54	5	33,34
RAZ280020540	2" - 54	1	32,95

clicca il seguente link: www.assotherm.it o scannerizza il QR-Code per scaricare le schede tecniche dei prodotti



RAZ 90

Curva a pressare femmina / Female press Elbow



Cod.	Size		€ / Cad.
RAZ090000150	15	25	4,15
RAZ090000180	18	15	5,20
RAZ090000220	22	15	5,51
RAZ090000280	28	5	6,98
RAZ090000350	35	5	11,17
RAZ090000420	42	5	20,59
RAZ090000540	54	3	27,30
RAZ090000760	76	3	72,58
RAZ090000890	89	3	93,92
RAZ090001080	108	3	119,54

RAZ 92

Curva a pressare maschio - femmina / Male - female press Elbow



Cod.	Size		€ / Cad.
RAZ092000150	15	25	4,15
RAZ092000180	18	15	4,65
RAZ092000220	22	15	5,73
RAZ092000280	28	5	7,26
RAZ092000350	35	5	11,29
RAZ092000420	42	5	19,85
RAZ092000540	54	3	27,41
RAZ092000760	76	3	71,13
RAZ092000890	89	3	92,05
RAZ092001080	108	3	117,15

RAZ 120

Curva a pressare a 45° femmina / 45° female press elbow



Cod.	Size		€ / Cad.
RAZ120000150	15	25	5,50
RAZ120000180	18	25	6,00
RAZ120000220	22	25	6,80
RAZ120000280	28	10	7,85
RAZ120000350	35	10	10,05
RAZ120000420	42	10	16,25
RAZ120000540	54	3	21,50
RAZ120000760	76	3	76,78
RAZ120000890	89	3	86,75
RAZ120001080	108	3	108,59

RAZ 121

Curva a pressare a 45° maschio/femmina / 45° male/female press elbow



Cod.	Size		€ / Cad.
RAZ121000150	15	10	5,30
RAZ121000180	18	10	5,60
RAZ121000220	22	10	6,75
RAZ121000280	28	10	7,84
RAZ121000350	35	4	9,95
RAZ121000420	42	2	16,00
RAZ121000540	54	2	20,70
RAZ121000760	76	2	76,76
RAZ121000890	89	2	86,75
RAZ121001080	108	2	108,57

clicca il seguente link: www.assotherm.it o scannerizza il QR-Code per scaricare le schede tecniche dei prodotti



RAZ 261

Curva uscita filetto maschio / Male press elbow



Cod.	Size		€ / Cad.
RAZ261003150	3/8" - 15	15	9,90
RAZ261005150	1/2" - 15	15	7,09
RAZ261007220	3/4" - 22	10	9,35
RAZ261010280	1" - 28	10	15,58
RAZ261012350	1" 1/4 - 35	10	22,29
RAZ261015420	1" 1/2 - 42	10	27,96
RAZ261020540	2" - 54	5	41,24

RAZ 262

Curva uscita filetto femmina / Female press elbow



Cod.	Size		€ / Cad.
RAZ262005150	1/2" - 15	15	7,34
RAZ262005180	1/2" - 18	15	10,33
RAZ262007220	3/4" - 22	15	11,53
RAZ262010280	1" - 28	10	14,09
RAZ262012350	1" 1/4 - 35	10	22,76

RAZ 290

Tappo a pressare femmina / Press female cap



Cod.	Size		€ / Cad.
RAZ290000150	15	1	2,82
RAZ290000180	18	1	4,18
RAZ290000220	22	1	4,56
RAZ290000280	28	1	6,15
RAZ290000350	35	1	7,90
RAZ290000420	42	1	11,53
RAZ290000540	54	1	29,42
RAZ290000760	76	1	33,17
RAZ290000890	89	1	36,50
RAZ290001080	108	1	49,78

RAZ 227

Flangia con manicotto a pressare / Straight coupling with flange



Cod.	Size		€ / Cad.
RAZ227000280	28	1	47,77
RAZ227000350	35	1	62,97
RAZ227000420	42	1	71,94
RAZ227000540	54	1	95,42
RAZ227000760	76	1	124,54
RAZ227000890	89	1	154,98
RAZ227001080	108	1	185,46

clicca il seguente link: www.assotherm.it o scannerizza il QR-Code
per scaricare le schede tecniche dei prodotti



RAZ 130

Tee a pressione / Press Tee



Cod.	Size		€ / Cad.
RAZ130000150	15	10	7,41
RAZ130000180	18	10	4,94
RAZ130000220	22	10	8,80
RAZ130000280	28	4	10,20
RAZ130000350	35	4	14,00
RAZ130000420	42	2	18,55
RAZ130000540	54	2	22,70
RAZ130000760	76	2	66,77
RAZ130000890	89	2	95,68
RAZ130001080	108	2	100,29

RAZ 130F

Tee a pressione, uscita filetto femmina / Female press Tee



Cod.	Size		€ / Cad.
RAZ130F05150	15 - 1/2" - 15	10	8,62
RAZ130F05180	18 - 1/2" - 18	10	8,90
RAZ130F05220	22 - 1/2" - 22	10	9,10
RAZ130F05280	28 - 1/2" - 28	10	10,45
RAZ130F05350	35 - 1/2" - 35	5	12,65
RAZ130F05420	42 - 1/2" - 42	5	15,82
RAZ130F05540	54 - 1/2" - 54	3	17,50
RAZ130F07180	18 - 3/4" - 18	10	11,01
RAZ130F07220	22 - 3/4" - 22	10	10,93
RAZ130F07280	28 - 3/4" - 28	10	18,06
RAZ130F07350	35 - 3/4" - 35	5	16,44
RAZ130F07420	42 - 3/4" - 42	5	19,94
RAZ130F07540	54 - 3/4" - 54	3	25,79
RAZ130F07760	76 - 3/4" - 76	3	64,64
RAZ130F07890	89 - 3/4" - 89	1	88,37
RAZ130F07108	108 - 3/4" - 108	1	103,19
RAZ130F20540	54 - 2" - 54	1	48,76
RAZ130F20760	76 - 2" - 76	1	74,29
RAZ130F20890	89 - 2" - 89	1	96,96
RAZ130F20108	108 - 2" - 108	1	115,53

RAZ 131

Tee a pressione ridotto / Reducing press Tee



Cod.	Size		€ / Cad.
RAZ131015180	18 - 15 - 18	10	5,12
RAZ131015220	22 - 15 - 22	10	8,39
RAZ131015280	28 - 15 - 28	10	8,90
RAZ131018220	22 - 18 - 22	10	5,76
RAZ131018280	28 - 18 - 28	10	6,92
RAZ131018350	35 - 18 - 35	10	9,31
RAZ131022280	28 - 22 - 28	10	9,80
RAZ131022350	35 - 22 - 35	4	11,80
RAZ131022420	42 - 22 - 42	4	11,61
RAZ131022540	54 - 22 - 54	4	18,35
RAZ131028350	35 - 28 - 35	4	12,23
RAZ131028420	42 - 28 - 42	4	11,95
RAZ131028540	54 - 28 - 54	4	19,33
RAZ131035420	42 - 35 - 42	1	18,75
RAZ131035540	54 - 35 - 54	1	20,09
RAZ131042540	54 - 42 - 54	1	23,30
RAZ131042760	76 - 42 - 76	1	63,06
RAZ131054760	76 - 54 - 76	1	63,74
RAZ131054890	89 - 54 - 89	1	76,16
RAZ131076108	108 - 76 - 108	1	99,60
RAZ131089108	108 - 89 - 108	1	106,22

clicca il seguente link: www.assotherm.it o scannerizza il QR-Code per scaricare le schede tecniche dei prodotti



RAZ 246

Manicotto ridotto M-F / Reducing press coupling M-F



Cod.	Size		€ / Cad.
RAZ246015180	15 - 18	25	3,69
RAZ246015220	15 - 22	25	3,69
RAZ246015280	15 - 28	10	4,35
RAZ246015350	15 - 35	10	6,05
RAZ246015420	15 - 42	10	8,32
RAZ246018220	18 - 22	10	3,78
RAZ246018280	18 - 28	10	4,53
RAZ246018350	18 - 35	10	6,32
RAZ246018420	18 - 42	10	8,24
RAZ246018540	18 - 54	10	9,86
RAZ246022280	22 - 28	10	4,50
RAZ246022350	22 - 35	10	6,16
RAZ246022420	22 - 42	10	8,50
RAZ246022540	22 - 54	10	10,12
RAZ246028350	28 - 35	10	6,46
RAZ246028420	28 - 42	10	12,70
RAZ246028540	28 - 54	10	20,00
RAZ246035420	35 - 42	10	7,60
RAZ246035540	35 - 54	10	14,65
RAZ246042540	42 - 54	10	8,70
RAZ246042760	42 - 76	1	43,80
RAZ246054760	54 - 76	1	43,59
RAZ246054890	54 - 89	1	49,10
RAZ246541080	54 - 108	1	66,26
RAZ246076890	76 - 89	1	51,74
RAZ246076108	76 - 108	1	67,37
RAZ246089108	89 - 108	1	69,63

RAZ 341

Bocchettone sede piana M-M / M-M flat seat union



Cod.	Size		€ / Cad.
RAZ341005150	1/2" - 15	10	13,88
RAZ341005180	1/2" - 18	10	17,63
RAZ341007220	3/4" - 22	5	21,56
RAZ341010280	1" - 28	4	36,20
RAZ341012350	1" 1/4 - 35	4	42,48
RAZ341015420	1" 1/2 - 42	2	47,82
RAZ341020540	2" - 54	1	70,78

clicca il seguente link: www.assotherm.it o scannerizza il QR-Code
per scaricare le schede tecniche dei prodotti



RAZ 240

Manicotto ridotto F-F / Reducing press coupling F-F



Cod.	Size		€ / Cad.
RAZ240015180	15 - 18		5,93
RAZ240015220	15 - 22		6,23
RAZ240015280	15 - 28		7,09
RAZ240015350	15 - 35		8,30
RAZ240015420	15 - 42		10,27
RAZ240015540	15 - 54		12,47
RAZ240018220	18 - 22		6,36
RAZ240018280	18 - 28		7,22
RAZ240018350	18 - 35		8,42
RAZ240018420	18 - 42		10,37
RAZ240018540	18 - 54		12,61
RAZ240022280	22 - 28		7,47
RAZ240022350	22 - 35		8,88
RAZ240022420	22 - 42		10,63
RAZ240022540	22 - 54		12,98
RAZ240028350	28 - 35		9,30
RAZ240028420	28 - 42		10,97
RAZ240028540	28 - 54		13,22
RAZ240035420	35 - 42		11,87
RAZ240035540	35 - 54		14,00
RAZ240042540	42 - 54		15,34
RAZ240042760	42 - 76		28,69
RAZ240054760	54 - 76		29,67
RAZ240054890	54 - 89		38,59
RAZ240541080	54 - 108		50,51
RAZ240076890	76 - 89		50,25
RAZ240076108	76 - 108		57,89
RAZ240089108	89 - 108		64,28

clicca il seguente link: www.assotherm.it o scannerizza il QR-Code
per scaricare le schede tecniche dei prodotti



RACCORDI A PRESSARE IN RAME PER ACQUA E GAS



IPR Sistema Press Fittings in rame Acqua/Gas

Le tubazioni del sistema IPR PRESS RAME sono realizzati mediante l'uso di tecnologie avanzate che permettono bassi livelli di residuo carbonioso, secondo quanto previsto dalla norma EN 1057, con lega Cu-DHP CW024A (Cu=99,90% min.).

Le tubazioni sono fornite in barre da 5 metri.

I raccordi del sistema press fittings IPR PRESS RAME sono forniti in dimensioni da 15 mm a 54 mm. La famiglia è composta da raccorderie in rame e bronzo sulle quali è installata una guarnizione in EPDM nera. Le guarnizioni ricoprono i parametri di igiene secondo quanto contenuto nel DVGW W 270 standard.

Il Sistema IPR RAME PRESS è concepito per utensili e ganasce di profilo "M", secondo gli usi indicati nel manuale tecnico, scaricabile dal sito www.assotherm.it



IPR Copper Press Fittings System Water / Gas

IPR COPPER PRESS pipe is manufactured with the most modern technologies available on the market in order to guarantee the lower level of residual carbon, following European manufacturing standard EN 1057, by alloy Cu-DHP CW024A (Cu=99,90% min.). Pipe is supplied in 5 meters length rods.

IPR PRESS COPPER fittings can be supplied in dimensions 15 - 54mm. This includes a complete range of copper and red bronze pressfittings with black, factory installed EPDM gaskets. The gasket fulfils all hygiene requirements, such as DVGW W 270.

IPR COPPER PRESS is designed for "M" Profile tools and pressing jaws and use, as indicated in the Technical Handbook downloadable on www.assotherm.it

 **Raccordi a pressare in rame per acqua e gas (IPR-RRP)**

 **Press fittings in copper for water and gas (IPR-RRP)**

Profilo di pressatura: "M" / Press profile: "M"

RRP 270M

Manicotto con battuta a pressare / Press coupling



Cod.	Size		€ / Cad.
RRP27000015M	15	10	3,16
RRP27000018M	18	10	3,80
RRP27000022M	22	10	4,39
RRP27000028M	28	10	8,46
RRP27000035M	35	10	10,75

RRP 271M

Raccordo uscita filetto maschio / Male press coupling



Cod.	Size		€ / Cad.
RRP27100515M	1/2" - 15	10	4,11
RRP27100522M	1/2" - 22	10	6,67
RRP27100718M	3/4" - 18	10	6,92
RRP27100722M	3/4" - 22	10	6,18
RRP27100728M	3/4" - 28	10	19,89
RRP27101022M	1" - 22	5	10,84
RRP27101028M	1" - 28	5	10,88
RRP27101235M	1" 1/4 - 35	5	24,98

RRP 280M

Raccordo uscita filetto femmina / Female press coupling



Cod.	Size		€ / Cad.
RRP28000515M	1/2" - 15	10	4,45
RRP28000522M	1/2" - 22	10	6,92
RRP28000718M	3/4" - 18	10	10,38
RRP28000722M	3/4" - 22	10	7,29
RRP28001028M	1" - 28	5	11,64
RRP28001235M	1" 1/4 - 35	5	26,95

RRP 90M

Curva a pressare femmina / Press equal elbow



Cod.	Size		€ / Cad.
RRP09000015M	15	10	3,79
RRP09000018M	18	10	4,84
RRP09000022M	22	10	6,03
RRP09000028M	28	5	11,62
RRP09000035M	35	5	21,46

clicca il seguente link: www.assotherm.it o scannerizza il QR-Code per scaricare le schede tecniche dei prodotti



RRP 92M

Curva a pressare maschio/femmina / Male/female press elbow



Cod.	Size		€ / Cad.
RRP09200015M	15	10	3,57
RRP09200018M	18	10	4,84
RRP09200022M	22	10	5,84
RRP09200028M	28	5	12,64
RRP09200035M	35	5	21,46

RRP 120M

Curva a pressare a 45° femmina / Press elbow 45°



Cod.	Size		€ / Cad.
RRP12000015M	15	10	4,02
RRP12000018M	18	10	4,88
RRP12000022M	22	10	5,50
RRP12000028M	28	5	15,37
RRP12000035M	35	5	20,69

RRP 122M

Curva a pressare a 45° maschio/femmina / Male/female press elbow 45°



Cod.	Size		€ / Cad.
RRP12200015M	15	10	3,46
RRP12200018M	18	10	4,88
RRP12200022M	22	10	5,50
RRP12200028M	28	5	14,70
RRP12200035M	35	5	20,69

RRP 130M

Tee a pressare / Press Tee



Cod.	Size		€ / Cad.
RRP13000015M	15	10	6,24
RRP13000018M	18	10	9,65
RRP13000022M	22	10	10,14
RRP13000028M	28	5	16,43
RRP13000035M	35	5	30,20

RRP 131M

Tee a pressare ridotto / Reducing press Tee



Cod.	Size		€ / Cad.
RRP13100BABM	18 - 15 - 18	10	8,59
RRP13100CACM	22 - 15 - 22	10	9,65
RRP13100DADM	28 - 15 - 28	5	17,23
RRP13100DBDM	28 - 18 - 28	5	20,23
RRP13100DCDM	28 - 22 - 28	5	17,86
RRP13100ECEM	35 - 22 - 35	5	26,32
RRP13100EDEM	35 - 28 - 35	5	30,54

clicca il seguente link: www.assotherm.it o scannerizza il QR-Code per scaricare le schede tecniche dei prodotti



RRP 130FM

Tee a pressare uscita filetto femmina / Female Press Tee



Cod.	Size		€ / Cad.
RRP130F0515M	1/2" - 15	10	15,67
RRP130F0522M	1/2" - 22	10	21,25
RRP130F0528M	1/2" - 28	5	26,82
RRP130F0535M	1/2" - 35	5	32,67
RRP130F0722M	3/4" - 22	5	26,93
RRP130F0728M	3/4" - 28	5	30,53

RRP 246M

Manicotto ridotto / Reducing coupling



Cod.	Size		€ / Cad.
RRP24601815M	15 - 18	10	3,33
RRP24602215M	22 - 15	10	3,44
RRP24602218M	22 - 18	10	3,57
RRP24602815M	28 - 15	10	8,31
RRP24602818M	28 - 18	10	8,51
RRP24602822M	28 - 22	10	8,61
RRP24603522M	35 - 22	10	10,59
RRP24603528M	35 - 28	10	11,10

RRP 290M

Tappo a pressare / Press female cap



Cod.	Size		€ / Cad.
RRP29000018M	18	10	9,16
RRP29000022M	22	10	10,36
RRP29000028M	28	5	15,45
RRP29000035M	35	5	20,98

clicca il seguente link: www.assotherm.it o scannerizza il QR-Code per scaricare le schede tecniche dei prodotti





TUBAZIONI PER SISTEMI A PRESSARE



RAXTUBO

Tubo INOX AISI 316L / Stainless steel pipe AISI 316L



Cod.	Size		€ / Cad.
RAXTUB316-015	15 x 1	6 m	
RAXTUB316-018	18 x 1	6 m	
RAXTUB316-022	22 x 1,2	6 m	
RAXTUB316-028	28 x 1,2	6 m	
RAXTUB316-035	35 x 1,5	6 m	
RAXTUB316-042	42 x 1,5	6 m	
RAXTUB316-054	54 x 1,5	6 m	
RAXTUB316-076	76 x 2	6 m	
RAXTUB316-089	89 x 2	6 m	
RAXTUB316-108	108 x 2	6 m	

RAZTUBO

Tubo INOX AISI 304L / Stainless steel pipe AISI 304L



Cod.	Size		€ / Cad.
RAZTUB304-015	15 x 1	6 m	
RAZTUB304-018	18 x 1	6 m	
RAZTUB304-022	22 x 1,2	6 m	
RAZTUB304-028	28 x 1,2	6 m	
RAZTUB304-035	35 x 1,5	6 m	
RAZTUB304-042	42 x 1,5	6 m	
RAZTUB304-054	54 x 1,5	6 m	
RAZTUB304-076	76 x 2	6 m	
RAZTUB304-089	89 x 2	6 m	
RAZTUB304-108	108 x 2	6 m	

RACTUBO

Tubo acciaio al carbonio galvanizzato / Galvanized carbon steel pipe



Cod.	Size		€ / Cad.
RACTUB000150	15 x 1,2	6 m	
RACTUB000180	18 x 1,2	6 m	
RACTUB000220	22 x 1,5	6 m	
RACTUB000280	28 x 1,5	6 m	
RACTUB000350	35 x 1,5	6 m	
RACTUB000420	42 x 1,5	6 m	
RACTUB000540	54 x 1,5	6 m	
RACTUB000760	76 x 2	6 m	
RACTUB000890	89 x 2	6 m	
RACTUB001080	108 x 2	6 m	

CONDY RAME

Tubo rame in rotolo pre-isolato per condizionamento / Copper tube in pre-insulated roll for conditioning



Cod.	Size	Isolation		€ / Cad.
TUBORA0208RC	1/4" x 0,8	6 mm	50 m	
TUBORA0308RC	3/8" x 0,8	6 mm	50 m	
TUBORA0508RC	1/2" x 0,8	9 mm	50 m	
TUBORA0610RC	5/8" x 1	9 mm	50 m	
TUBORA0710RC	3/4" x 1	9 mm	25 m	
TUBORA0810RC	7/8" x 1	9 mm	25 m	

clicca il seguente link: www.assotherm.it o scannerizza il QR-Code per scaricare le schede tecniche dei prodotti



TUBORAME

Tubo rame / Copper pipe



Cod.	Size		€ / Cad.
TUBORAME15V	15	5 m	
TUBORAME18V	18	5 m	
TUBORAME22V	22	5 m	
TUBORAME28V	28	5 m	
TUBORAME35V	35	5 m	

TUBOMULTI

Tubo multistrato / Multilayer pipe



In rotolo / In roll			
Cod.	Size		€ / Cad.
TUBOMULT0016	16 x 2	100 m	
TUBOMULTD016	16 x 2	250 m	
TUBOMULTC016	16 x 2	500 m	
TUBOMULT0020	20 x 2	100 m	
TUBOMULT0026	26 x 3	50m	
TUBOMULT0032	32 x 3	50m	



In verga / In pipe			
Cod.	Size		€ / Cad.
TUBOMULTV032	32 x 3	4 m	
TUBOMULTV040	40 x 3,5	4 m	
TUBOMULTV050	50 x 4	4 m	
TUBOMULTV063	63 x 4,5	4 m	

TUBOKK

Tubo multistrato pre-isolato / Multilayer pipe insulated



In rotolo / In roll						€ / Cad.
Cod.	Size	Isolation				
TUBOMULTKK16	16 x 2	6 mm	Rosso / Red	Sanitario e riscaldamento / Heating and sanitary applications	50 m	
TUBOMULTKK20	20 x 2	9 mm	Rosso / Red		50 m	
TUBOMULTKK26	26 x 3	10 mm	Rosso / Red		50 m	
TUBOMULTKK32	32 x 3	10 mm	Rosso / Red		25 m	
TUBOMULTKK16B	16 x 2	6 mm	Blu / Blue	Sanitario e riscaldamento / Heating and sanitary applications	50 m	
TUBOMULTKK20B	20 x 2	9 mm	Blu / Blue		50 m	
TUBOMULTKK26B	26 x 3	10 mm	Blu / Blue		50 m	
TUBOMULTKK32B	32 x 3	10 mm	Blu / Blue		25 m	
TUBOMULTKX16	16 x 2	10 mm	Verde / Green	Condizionamento e refrigerazione / Air cooling and chiller	50 m	
TUBOMULTKX20	20 x 2	13 mm	Verde / Green		50 m	
TUBOMULTKX26	26 x 3	13 mm	Verde / Green		50 m	
TUBOMULTKX32	32 x 3	13 mm	Verde / Green		25 m	

TUBOPEXA

Tubo PEX-A / PEX-A Pipe



Cod.	Size		€ / Cad.
TUBOPEXA17300	17 x 2	300 m	
TUBOPEXA17600	17 x 2	600 m	

clicca il seguente link: www.assotherm.it o scannerizza il QR-Code per scaricare le schede tecniche dei prodotti



RACCORDERIA



RACCORDI FILETTATI IN GHISA MALLEABILE



Raccordi in ghisa malleabile zincata**Malleable iron fittings**

Materiale / Material : Ghisa malleabile

Temperatura d'esercizio / Operating temperature : -10 ↔ +95 °C

Filettatura / Threads : UNI EN 10226-1 (ex iso 7/1)

Conformità / According to : EN 10242

RA 90

Gomito F-F / Elbow F-F



Cod.	Size			€ / Cad.
RA0090000001	1/8"	F / F	10	2,37
RA0090000002	1/4"	F / F	10	1,90
RA0090000003	3/8"	F / F	10	1,69
RA0090000005	1/2"	F / F	10	1,15
RA0090000007	3/4"	F / F	10	1,82
RA0090000010	1"	F / F	10	2,66
RA0090000012	1" 1/4	F / F	5	5,11
RA0090000015	1" 1/2	F / F	5	8,20
RA0090000020	2"	F / F	1	9,42
RA0090000025	2" 1/2	F / F	1	27,58
RA0090000030	3"	F / F	1	37,39
RA0090000040	4"	F / F	1	67,66
RA0090000050	5"	F / F	1	248,81
RA0090000060	6"	F / F	1	410,78

RA 91

Gomito ridotto F-F / Reducing elbow F-F



Cod.	Size			€ / Cad.
RA0091000705	3/4" - 1/2"	F / F	10	2,44
RA0091001005	1" - 1/2"	F / F	10	3,59
RA0091001007	1" - 3/4"	F / F	10	3,76
RA0091001210	1" 1/4 - 1"	F / F	5	6,11
RA0091001510	1" 1/2 - 1"	F / F	5	8,94
RA0091001512	1" 1/2 - 1" 1/4	F / F	5	9,71
RA0091002015	2" - 1" 1/2	F / F	5	15,65
RA0091002520	2" 1/2 - 2"	F / F	5	37,85
RA0091003015	3" - 1" 1/2	F / F	5	57,06
RA0091003020	3" - 2"	F / F	5	72,12
RA0091003025	3" - 2" 1/2	F / F	5	97,57

RA 92

Gomito M-F / Elbow M-F



Cod.	Size			€ / Cad.
RA0092000001	1/8"	M / F	10	2,86
RA0092000002	1/4"	M / F	10	2,07
RA0092000003	3/8"	M / F	10	1,90
RA0092000005	1/2"	M / F	10	1,32
RA0092000007	3/4"	M / F	10	2,07
RA0092000010	1"	M / F	10	3,47
RA0092000012	1" 1/4	M / F	5	5,96
RA0092000015	1" 1/2	M / F	5	8,96
RA0092000020	2"	M / F	1	11,43
RA0092000025	2" 1/2	M / F	1	28,45
RA0092000030	3"	M / F	1	37,46
RA0092000040	4"	M / F	1	63,97

clicca il seguente link: www.assotherm.it o scannerizza il QR-Code per scaricare le schede tecniche dei prodotti



RA 130

Tee F-F-F / Tee F-F-F



Cod.	Size			€ / Cad.
RA013000001	1/8"	F / F / F	10	3,03
RA013000002	1/4"	F / F / F	10	2,77
RA013000003	3/8"	F / F / F	10	2,37
RA013000005	1/2"	F / F / F	10	1,53
RA013000007	3/4"	F / F / F	10	2,66
RA013000010	1"	F / F / F	10	3,92
RA013000012	1" 1/4	F / F / F	5	6,91
RA013000015	1" 1/2	F / F / F	5	10,74
RA013000020	2"	F / F / F	1	14,68
RA013000025	2" 1/2	F / F / F	1	33,64
RA013000030	3"	F / F / F	1	44,95
RA013000040	4"	F / F / F	1	88,03
RA013000050	5"	F / F / F	1	368,15
RA013000060	6"	F / F / F	1	516,02

RA 131

Tee ridotto F-F-F / Reducing Tee F-F-F



Cod.	Size			€ / Cad.
RA0131050305	1/2" - 3/8" - 1/2"	F / F / F	10	3,06
RA0131070505	3/4" - 1/2" - 1/2"	F / F / F	10	3,06
RA0131070507	3/4" - 1/2" - 3/4"	F / F / F	10	2,86
RA0131100505	1" - 1/2" - 1/2"	F / F / F	10	6,45
RA0131100510	1" - 1/2" - 1"	F / F / F	10	3,71
RA0131100710	1" - 3/4" - 1"	F / F / F	10	4,00
RA0131101210	1" - 1" 1/4 - 1"	F / F / F	10	9,31
RA0131120512	1" 1/4 - 1/2" - 1" 1/4	F / F / F	5	6,21
RA0131120712	1" 1/4 - 3/4" - 1" 1/4	F / F / F	5	6,57
RA0131121012	1" 1/4 - 1" - 1" 1/4	F / F / F	5	7,35
RA0131150515	1" 1/2" - 1/2" - 1" 1/2"	F / F / F	5	8,38
RA0131150715	1" 1/2" - 3/4" - 1" 1/2"	F / F / F	5	9,06
RA0131151015	1" 1/2" - 1" - 1" 1/2"	F / F / F	5	9,79
RA0131151215	1" 1/2" - 1" 1/4 - 1" 1/2"	F / F / F	5	13,28
RA0131200520	2" - 1/2" - 2"	F / F / F	1	12,35
RA0131200720	2" - 3/4" - 2"	F / F / F	1	16,04
RA0131201020	2" - 1" - 2"	F / F / F	1	12,45
RA0131201220	2" - 1" 1/4 - 2"	F / F / F	1	16,04
RA0131201520	2" - 1" 1/2 - 2"	F / F / F	1	18,48
RA0131250525	2" 1/2 - 1/2" - 2" 1/2	F / F / F	1	45,91
RA0131250725	2" 1/2 - 3/4" - 2" 1/2	F / F / F	1	26,53
RA0131251025	2" 1/2 - 1" - 2" 1/2	F / F / F	1	25,43
RA0131251225	2" 1/2 - 1" 1/4 - 2" 1/2	F / F / F	1	34,89
RA0131251525	2" 1/2 - 1" 1/2 - 2" 1/2	F / F / F	1	30,38
RA0131252025	2" 1/2 - 2" - 2" 1/2	F / F / F	1	34,17
RA0131301030	3" - 1" - 3"	F / F / F	1	41,66
RA0131301230	3" - 1" 1/4 - 3"	F / F / F	1	47,91
RA0131301530	3" - 1" 1/2 - 3"	F / F / F	1	48,00
RA0131302030	3" - 2" - 3"	F / F / F	1	44,61
RA0131402040	4" - 2" - 4"	F / F / F	1	78,58
RA0131402540	4" - 2" 1/2 - 4"	F / F / F	1	100,37
RA0131403040	4" - 3" - 4"	F / F / F	1	83,54

clicca il seguente link: www.assotherm.it o scannerizza il QR-Code
per scaricare le schede tecniche dei prodotti



RA 270

Manicotto F-F / Coupling F-F



Cod.	Size			€ / Cad.
RA0270000001	1/8"	F / F	10	1,89
RA0270000002	1/4"	F / F	10	1,89
RA0270000003	3/8"	F / F	10	1,61
RA0270000005	1/2"	F / F	10	1,32
RA0270000007	3/4"	F / F	10	1,79
RA0270000010	1"	F / F	10	2,37
RA0270000012	1" 1/4	F / F	5	3,71
RA0270000015	1" 1/2	F / F	5	5,36
RA0270000020	2"	F / F	1	7,68
RA0270000025	2" 1/2	F / F	1	21,32
RA0270000030	3"	F / F	1	25,60
RA0270000040	4"	F / F	1	59,70
RA0270000050	5"	F / F	1	174,68
RA0270000060	6"	F / F	1	248,04

RA 529

Manicotto M-F / Coupling M-F



Cod.	Size			€ / Cad.
RA0529000003	3/8"	M / F	10	2,35
RA0529000005	1/2"	M / F	10	2,40
RA0529000007	3/4"	M / F	10	3,45
RA0529000010	1"	M / F	10	5,44
RA0529000012	1" 1/4	M / F	5	9,48
RA0529000015	1" 1/2	M / F	5	10,05
RA0529000020	2"	M / F	1	17,71

RA 340

Bocchettone dritto F-F / Straight union F-F



Cod.	Size			€ / Cad.
RA0340000001	1/8"	F / F	10	17,73
RA0340000002	1/4"	F / F	10	8,52
RA0340000003	3/8"	F / F	10	7,69
RA0340000005	1/2"	F / F	10	7,42
RA0340000007	3/4"	F / F	10	6,67
RA0340000010	1"	F / F	10	7,70
RA0340000012	1" 1/4	F / F	5	13,24
RA0340000015	1" 1/2	F / F	5	15,49
RA0340000020	2"	F / F	1	24,78
RA0340000025	2" 1/2	F / F	1	54,46
RA0340000030	3"	F / F	1	75,93
RA0340000040	4"	F / F	1	153,31

→ Sede piana a richiesta / Flat seat on demand

clicca il seguente link: www.assotherm.it o scannerizza il QR-Code
per scaricare le schede tecniche dei prodotti



RA 341

Bocchettone dritto M-F / Straight union M-F



Cod.	Size			€ / Cad.
RA0341000002	1/4"	M / F	10	8,86
RA0341000003	3/8"	M / F	10	6,91
RA0341000005	1/2"	M / F	10	5,74
RA0341000007	3/4"	M / F	10	6,91
RA0341000010	1"	M / F	10	8,59
RA0341000012	1" 1/4	M / F	5	13,67
RA0341000015	1" 1/2	M / F	5	17,51
RA0341000020	2"	M / F	1	27,13
RA0341000025	2" 1/2	M / F	1	59,41
RA0341000030	3"	M / F	1	92,91
RA0341000040	4"	M / F	1	170,33

→ Sede piana a richiesta / Flat seat on demand

RA 241

Riduzione M-F / Reducing coupling M-F



Cod.	Size			€ / Cad.
RA0241000503	1/2" - 3/8"	M / F	10	1,17
RA0241000703	3/4" - 3/8"	M / F	10	1,64
RA0241000705	3/4" - 1/2"	M / F	10	1,24
RA0241001005	1" - 1/2"	M / F	10	1,74
RA0241001007	1" - 3/4"	M / F	10	1,64
RA0241001205	1" 1/4 - 1/2"	M / F	5	3,00
RA0241001207	1" 1/4 - 3/4"	M / F	5	2,69
RA0241001210	1" 1/4 - 1"	M / F	5	2,00
RA0241001505	1" 1/2 - 1/2"	M / F	5	3,99
RA0241001507	1" 1/2 - 3/4"	M / F	5	4,39
RA0241001510	1" 1/2 - 1"	M / F	5	2,95
RA0241001512	1" 1/2 - 1" 1/4	M / F	5	3,00
RA0241002005	2" - 1/2"	M / F	5	7,98
RA0241002007	2" - 3/4"	M / F	1	7,88
RA0241002010	2" - 1"	M / F	1	6,45
RA0241002012	2" - 1" 1/4	M / F	1	6,16
RA0241002015	2" - 1" 1/2	M / F	1	5,52
RA0241002510	2" 1/2 - 1"	M / F	1	12,70
RA0241002512	2" 1/2 - 1" 1/4	M / F	1	14,69
RA0241002515	2" 1/2 - 1" 1/2	M / F	1	13,88
RA0241002520	2" 1/2 - 2"	M / F	1	10,62
RA0241003010	3" - 1"	M / F	1	19,89
RA0241003012	3" - 1" 1/4	M / F	1	19,89
RA0241003015	3" - 1" 1/2	M / F	1	18,45
RA0241003020	3" - 2"	M / F	1	13,69
RA0241003025	3" - 2" 1/2	M / F	1	15,49
RA0241004010	4" - 1"	M / F	1	20,79
RA0241004012	4" - 1" 1/4	M / F	1	21,10
RA0241004015	4" - 1" 1/2	M / F	1	21,10
RA0241004020	4" - 2"	M / F	1	39,80
RA0241004025	4" - 2" 1/2	M / F	1	29,63
RA0241004030	4" - 3"	M / F	1	28,43
RA0241005040	5" - 4"	M / F	1	130,02
RA0241006020	6" - 2"	M / F	1	157,41
RA0241006030	6" - 3"	M / F	1	157,41
RA0241006040	6" - 4"	M / F	1	253,82

clicca il seguente link: www.assotherm.it o scannerizza il QR-Code
per scaricare le schede tecniche dei prodotti



RA 290

Tappo con bordo M / Plug beaded M



Cod.	Size			€ / Cad.
RA0290000001	1/8"	M	10	1,30
RA0290000002	1/4"	M	10	1,13
RA0290000003	3/8"	M	10	0,91
RA0290000005	1/2"	M	10	0,91
RA0290000007	3/4"	M	10	1,24
RA0290000010	1"	M	10	1,36
RA0290000012	1" 1/4	M	5	2,59
RA0290000015	1" 1/2	M	5	3,15
RA0290000020	2"	M	1	5,46
RA0290000025	2" 1/2	M	1	11,95
RA0290000030	3"	M	1	15,39
RA0290000040	4"	M	1	21,17

RA 300

Tappo F / Stop end F



Cod.	Size			€ / Cad.
RA0300000001	1/8"	F	10	2,44
RA0300000002	1/4"	F	10	1,41
RA0300000003	3/8"	F	10	1,32
RA0300000005	1/2"	F	10	1,49
RA0300000007	3/4"	F	10	1,79
RA0300000010	1"	F	10	2,10
RA0300000012	1" 1/4	F	5	3,15
RA0300000015	1" 1/2	F	5	3,92
RA0300000020	2"	F	1	7,18
RA0300000025	2" 1/2	F	1	13,11
RA0300000030	3"	F	1	14,30
RA0300000040	4"	F	1	31,25

RA 280

Niplo M-M / Nipple M-M



Cod.	Size			€ / Cad.
RA0280000001	1/8"	M / M	10	2,19
RA0280000002	1/4"	M / M	10	1,95
RA0280000003	3/8"	M / M	10	2,22
RA0280000005	1/2"	M / M	10	1,17
RA0280000007	3/4"	M / M	10	1,51
RA0280000010	1"	M / M	10	2,19
RA0280000012	1" 1/4	M / M	5	3,71
RA0280000015	1" 1/2	M / M	5	4,29
RA0280000020	2"	M / M	1	7,49
RA0280000025	2" 1/2	M / M	1	13,48
RA0280000030	3"	M / M	1	16,22
RA0280000040	4"	M / M	1	59,70

clicca il seguente link: www.assotherm.it o scannerizza il QR-Code per scaricare le schede tecniche dei prodotti



RA 245

Nipplo ridotto M-M / Reducing nipple M-M



Cod.	Size			€ / Cad.
RA0245000302	3/8" - 1/4"	M / M	10	2,70
RA0245000502	1/2" - 1/4"	M / M	10	3,00
RA0245000503	1/2" - 3/8"	M / M	10	2,78
RA0245000702	3/4" - 1/4"	M / M	10	5,64
RA0245000703	3/4" - 3/8"	M / M	10	4,93
RA0245000705	3/4" - 1/2"	M / M	10	2,41
RA0245001003	1" - 3/8"	M / M	10	6,00
RA0245001005	1" - 1/2"	M / M	10	4,89
RA0245001007	1" - 3/4"	M / M	10	2,78
RA0245001205	1" 1/4 - 1/2"	M / M	10	7,48
RA0245001207	1" 1/4 - 3/4"	M / M	10	6,35
RA0245001210	1" 1/4 - 1"	M / M	5	4,39
RA0245001505	1" 1/2 - 1/2"	M / M	5	3,70
RA0245001507	1" 1/2 - 3/4"	M / M	1	6,45
RA0245001510	1" 1/2 - 1"	M / M	1	10,23
RA0245001512	1" 1/2 - 1" 1/4	M / M	1	5,54
RA0245002005	2" - 1/2"	M / M	1	11,89
RA0245002007	2" - 3/4"	M / M	1	11,85
RA0245002010	2" - 1"	M / M	1	9,20
RA0245002012	2" - 1" 1/4	M / M	1	11,47
RA0245002015	2" - 1" 1/2	M / M	1	10,47
RA0245002510	2" 1/2 - 1"	M / M	1	17,66
RA0245002515	2" 1/2 - 1" 1/2	M / M	1	15,11
RA0245002520	2" 1/2 - 2"	M / M	1	24,71
RA0245003020	3" - 2"	M / M	1	30,90
RA0245003025	3" - 2" 1/2	M / M	1	40,54
RA0245004025	4" - 2" 1/2	M / M	1	88,32
RA0245004030	4" - 3"	M / M	1	76,09

RA 180

Croce F-F-F-F / Cross fitting F-F-F-F



Cod.	Size			€ / Cad.
RA0180000002	1/4"	F / F / F / F	10	5,23
RA0180000003	3/8"	F / F / F / F	10	5,64
RA0180000005	1/2"	F / F / F / F	10	5,54
RA0180000007	3/4"	F / F / F / F	10	8,25
RA0180000010	1"	F / F / F / F	10	10,23
RA0180000012	1" 1/4	F / F / F / F	5	13,72
RA0180000015	1" 1/2	F / F / F / F	5	18,28
RA0180000020	2"	F / F / F / F	1	26,51
RA0180000025	2" 1/2	F / F / F / F	1	59,96
RA0180000030	3"	F / F / F / F	1	69,03
RA0180000040	4"	F / F / F / F	1	114,46

clicca il seguente link: www.assotherm.it o scannerizza il QR-Code per scaricare le schede tecniche dei prodotti



RA 240

Manicotto ridotto F-F / Reducing coupling F-F



Cod.	Size			€ / Cad.
RA0240000503	1/2" - 3/8"	F / F	10	2,00
RA0240000705	3/4" - 1/2"	F / F	10	2,35
RA0240001005	1" - 1/2"	F / F	10	2,95
RA0240001007	1" - 3/4"	F / F	5	2,69
RA0240001205	1" 1/4 - 1/2"	F / F	5	5,61
RA0240001207	1" 1/4 - 3/4"	F / F	1	4,96
RA0240001210	1" 1/4 - 1"	F / F	1	4,81
RA0240001505	1" 1/2 - 1/2"	F / F	1	8,67
RA0240001507	1" 1/2 - 3/4"	F / F	1	7,69
RA0240001510	1" 1/2 - 1"	F / F	1	5,84
RA0240001512	1" 1/2 - 1" 1/4	F / F	1	6,45
RA0240002005	2" - 1/2"	F / F	1	11,99
RA0240002007	2" - 3/4"	F / F	1	12,45
RA0240002010	2" - 1"	F / F	1	11,47
RA0240002012	2" - 1" 1/4	F / F	1	10,13
RA0240002015	2" - 1" 1/2	F / F	1	9,62
RA0240002505	2" 1/2 - 1/2"	F / F	1	26,64
RA0240002510	2" 1/2 - 1"	F / F	1	22,80
RA0240002512	2" 1/2 - 1" 1/4	F / F	1	28,28
RA0240002515	2" 1/2 - 1" 1/2	F / F	1	30,53
RA0240002520	2" 1/2 - 2"	F / F	1	25,90
RA0240003010	3" - 1"	F / F	1	40,62
RA0240003012	3" - 1" 1/4	F / F	1	38,20
RA0240003015	3" - 1" 1/2	F / F	1	27,97
RA0240003020	3" - 2"	F / F	1	40,84
RA0240003025	3" - 2" 1/2	F / F	1	46,47
RA0240004015	4" - 1" 1/2	F / F	1	77,70
RA0240004020	4" - 2"	F / F	1	70,63
RA0240004025	4" - 2" 1/2	F / F	1	73,80

RA 246

Manicotto ridotto F-M / Reducing coupling F-M



Cod.	Size			€ / Cad.
RA0246000201	1/4" - 1/8"	F / M	10	2,44
RA0246000302	3/8" - 1/4"	F / M	10	2,10
RA0246000502	1/2" - 1/4"	F / M	10	2,78
RA0246000503	1/2" - 3/8"	F / M	10	2,22
RA0246000703	3/4" - 3/8"	F / M	10	3,76
RA0246000705	3/4" - 1/2"	F / M	10	2,39
RA0246001005	1" - 1/2"	F / M	10	3,67
RA0246001007	1" - 3/4"	F / M	5	3,88
RA0246001205	1" 1/4 - 1/2"	F / M	5	9,37
RA0246001207	1" 1/4 - 3/4"	F / M	1	6,93
RA0246001210	1" 1/4 - 1"	F / M	1	4,30
RA0246001507	1" 1/2 - 3/4"	F / M	1	7,98
RA0246001510	1" 1/2 - 1"	F / M	1	8,25
RA0246001512	1" 1/2 - 1" 1/4	F / M	1	7,23
RA0246002010	2" - 1"	F / M	1	13,88
RA0246002012	2" - 1" 1/4	F / M	1	11,73
RA0246002015	2" - 1" 1/2	F / M	1	12,35
RA0246002515	2" 1/2 - 1" 1/2	F / M	1	24,60
RA0246002520	2" 1/2 - 2"	F / M	1	20,09
RA0246003020	3" - 2"	F / M	1	29,28
RA0246003025	3" - 2" 1/2	F / M	1	35,85

clicca il seguente link: www.assotherm.it o scannerizza il QR-Code per scaricare le schede tecniche dei prodotti



RA 96

Bocchettone curvo F-F / Bent union F-F



Cod.	Size			€ / Cad.
RA0096000002	1/4"	F / F	10	11,26
RA0096000003	3/8"	F / F	10	10,64
RA0096000005	1/2"	F / F	10	7,88
RA0096000007	3/4"	F / F	10	9,13
RA0096000010	1"	F / F	5	13,09
RA0096000012	1" 1/4	F / F	5	21,79
RA0096000015	1" 1/2	F / F	1	25,97
RA0096000020	2"	F / F	1	42,54
RA0096000025	2" 1/2	F / F	1	91,18
RA0096000030	3"	F / F	1	118,40

RA 98

Bocchettone curvo M-F / Bent union M-F



Cod.	Size			€ / Cad.
RA0098000002	1/4"	M / F	10	10,41
RA0098000003	3/8"	M / F	10	9,45
RA0098000005	1/2"	M / F	10	7,92
RA0098000007	3/4"	M / F	10	10,03
RA0098000010	1"	M / F	5	13,75
RA0098000012	1" 1/4	M / F	5	23,05
RA0098000015	1" 1/2	M / F	1	28,21
RA0098000020	2"	M / F	1	45,31
RA0098000025	2" 1/2	M / F	1	100,64
RA0098000030	3"	M / F	1	134,89

RA 372

Mezzo bocchettone / Half union



Cod.	Size			€ / Cad.
RA0372000005	1/2"	F	10	2,28
RA0372000007	3/4"	F	10	2,37
RA0372000010	1"	F	10	2,54
RA0372000012	1" 1/4	F	5	3,49
RA0372000015	1" 1/2	F	5	4,69
RA0372000020	2"	F	1	7,38

RA 374

Dado per RA 372 / Nut for RA 372



Cod.	Size			€ / Cad.
RA0374000005	1/2"		10	2,16
RA0374000007	3/4"		10	2,25
RA0374000010	1"		10	2,58
RA0374000012	1" 1/4		5	4,16
RA0374000015	1" 1/2		5	4,89
RA0374000020	2"		1	7,11

clicca il seguente link: www.assotherm.it o scannerizza il QR-Code per scaricare le schede tecniche dei prodotti



RA 01

Curva ampia 90° M-F / Large elbow 90° M-F



Cod.	Size			€ / Cad.
RA0010000005	1/2"	M / F	10	3,25
RA0010000007	3/4"	M / F	10	5,64
RA0010000010	1"	M / F	10	7,69
RA0010000012	1" 1/4	M / F	5	13,24
RA0010000015	1" 1/2	M / F	5	17,51
RA0010000020	2"	M / F	1	27,41

RA 02

Curva ampia 90° F-F / Large elbow 90° F-F



Cod.	Size			€ / Cad.
RA0020000005	1/2"	F / F	10	3,67
RA0020000007	3/4"	F / F	10	5,66
RA0020000010	1"	F / F	10	7,69
RA0020000012	1" 1/4	F / F	5	13,28
RA0020000015	1" 1/2	F / F	5	16,33
RA0020000020	2"	F / F	1	22,03

RA 40

Curva ampia 45° M-F / Large elbow 45° M-F



Cod.	Size			€ / Cad.
RA0040000005	1/2"	M / F	10	3,67
RA0040000007	3/4"	M / F	10	4,96
RA0040000010	1"	M / F	10	6,93
RA0040000012	1" 1/4	M / F	5	12,11
RA0040000015	1" 1/2	M / F	5	14,40
RA0040000020	2"	M / F	1	22,17

RA 41

Curva ampia 45° F-F / Large elbow 45° F-F



Cod.	Size			€ / Cad.
RA0041000005	1/2"	F / F	10	4,37
RA0041000007	3/4"	F / F	10	5,54
RA0041000010	1"	F / F	10	7,09
RA0041000012	1" 1/4	F / F	5	12,70
RA0041000015	1" 1/2	F / F	5	16,77
RA0041000020	2"	F / F	1	22,86

clicca il seguente link: www.assotherm.it o scannerizza il QR-Code per scaricare le schede tecniche dei prodotti



RA 120

Gomito 45° F-F / Elbow 45° F-F



Cod.	Size			€ / Cad.
RA012000002	1/4"	F / F	10	5,43
RA012000003	3/8"	F / F	10	4,59
RA012000005	1/2"	F / F	10	3,86
RA012000007	3/4"	F / F	10	4,76
RA012000010	1"	F / F	5	6,91
RA012000012	1" 1/4	F / F	5	12,58
RA012000015	1" 1/2	F / F	1	15,36
RA012000020	2"	F / F	1	19,47
RA012000025	2" 1/2	F / F	1	40,16
RA012000030	3"	F / F	1	39,63
RA012000040	4"	F / F	1	140,56

RA 121

Gomito 45° M-F / Elbow 45° M-F



Cod.	Size			€ / Cad.
RA0121000002	1/4"	M / F	10	4,30
RA0121000003	3/8"	M / F	10	3,59
RA0121000005	1/2"	M / F	10	3,54
RA0121000007	3/4"	M / F	10	4,50
RA0121000010	1"	M / F	5	6,91
RA0121000012	1" 1/4	M / F	5	12,94
RA0121000015	1" 1/2	M / F	1	13,94
RA0121000020	2"	M / F	1	17,14
RA0121000025	2" 1/2	M / F	1	33,53
RA0121000030	3"	M / F	1	41,20
RA0121000040	4"	M / F	1	153,06

RA 471

Gomito con Base F-F / Wall plate elbow F-F



Cod.	Size			€ / Cad.
RA0471000005	1/2"	F / F	10	7,35
RA0471000007	3/4"	F / F	10	14,14
RA0471000010	1"	F / F	10	27,84

RA 85

Scavalca tubo F-F / Crossover F-F



Cod.	Size			€ / Cad.
RA0085000003	3/8"	F / F	10	6,23
RA0085000005	1/2"	F / F	10	4,69
RA0085000007	3/4"	F / F	10	7,09
RA0085000010	1"	F / F	5	14,69
RA0085000012	1" 1/4	F / F	5	27,58

clicca il seguente link: www.assotherm.it o scannerizza il QR-Code per scaricare le schede tecniche dei prodotti



RA 500

Barilotto di prolunga M-M / Extension tube M-M



Cod.	Size			€ / Cad.
RA0500006003	3/8" - 60	M / M	1	1,11
RA0500007003	3/8" - 70	M / M	1	1,11
RA0500008003	3/8" - 80	M / M	1	1,20
RA0500010003	3/8" - 100	M / M	1	1,31
RA0500012003	3/8" - 120	M / M	1	1,55
RA0500015003	3/8" - 150	M / M	1	1,83
RA0500020003	3/8" - 200	M / M	1	2,30
RA0500025003	3/8" - 250	M / M	1	2,72
RA0500006005	1/2" - 60	M / M	1	1,11
RA0500007005	1/2" - 70	M / M	1	1,11
RA0500008005	1/2" - 80	M / M	1	1,20
RA0500010005	1/2" - 100	M / M	1	1,31
RA0500012005	1/2" - 120	M / M	1	1,55
RA0500015005	1/2" - 150	M / M	1	1,83
RA0500020005	1/2" - 200	M / M	1	2,30
RA0500025005	1/2" - 250	M / M	1	2,72
RA0500006007	3/4" - 60	M / M	1	1,31
RA0500007007	3/4" - 70	M / M	1	1,31
RA0500008007	3/4" - 80	M / M	1	1,46
RA0500010007	3/4" - 100	M / M	1	1,62
RA0500012007	3/4" - 120	M / M	1	1,79
RA0500015007	3/4" - 150	M / M	1	2,20
RA0500020007	3/4" - 200	M / M	1	2,72
RA0500025007	3/4" - 250	M / M	1	3,08
RA0500006010	1" - 60	M / M	1	1,62
RA0500007010	1" - 70	M / M	1	1,62
RA0500008010	1" - 80	M / M	1	1,83
RA0500010010	1" - 100	M / M	1	2,20
RA0500012010	1" - 120	M / M	1	2,41
RA0500015010	1" - 150	M / M	1	2,86
RA0500020010	1" - 200	M / M	1	3,60
RA0500025010	1" - 250	M / M	1	4,24

RA GGN

Guarnizione in gomma nera NBR per bocchettone / NBR black rubber gasket for union



Cod.	Size			€ / Cad.
RA00GGN00003	3/8"	M / F	10	1,10
RA00GGN00005	1/2"	M / F	10	1,30
RA00GGN00007	3/4"	M / F	10	1,70
RA00GGN00010	1"	M / F	5	2,35
RA00GGN00012	1" 1/4	M / F	5	3,60
RA00GGN00015	1" 1/2	M / F	1	4,50
RA00GGN00020	2"	M / F	1	5,90
RA00GGN00025	2" 1/2	M / F	1	10,00
RA00GGN00030	3"	M / F	1	20,00
RA00GGN00040	4"	M / F	1	25,00

clicca il seguente link: www.assotherm.it o scannerizza il QR-Code per scaricare le schede tecniche dei prodotti



RACCORDI FILETTATI IN OTTONE



Raccordi filettati in ottone**Brass threaded fittings**

Materiale / Material : Ottone / Brass (CW617N UNI EN 12165)

Temperatura d'esercizio / Operating temperature : 0 ↔ +95 °C

Pressione nominale / Nominal pressure: PN 25

RF 260F

Gomito F-F / Elbow F-F



Cod.	Size			€ / Cad.
RF0260F02000	1/4"	F / F	10	1,85
RF0260F03000	3/8"	F / F	10	2,08
RF0260F05000	1/2"	F / F	10	2,18
RF0260F07000	3/4"	F / F	10	3,49
RF0260F10000	1"	F / F	10	6,28
RF0260F12000	1" 1/4	F / F	5	14,82
RF0260F15000	1" 1/2	F / F	5	17,93
RF0260F20000	2"	F / F	5	31,90

RF 262A

Gomito M-F / Elbow M-F



Cod.	Size			€ / Cad.
RF0262A02000	1/4"	M / F	10	1,80
RF0262A03000	3/8"	M / F	10	1,89
RF0262A05000	1/2"	M / F	10	2,11
RF0262A07000	3/4"	M / F	10	3,52
RF0262A10000	1"	M / F	10	6,02
RF0262A12000	1" 1/4	M / F	5	10,96
RF0262A15000	1" 1/2	M / F	5	19,37
RF0262A20000	2"	M / F	5	33,34

RF 137

Kit contatore acqua + dado + guarnizione M-F / Kit water meter + nut + o-ring M-F



Cod.	Size			€ / Cad.
RF0137005007	1/2" x 3/4"	M / F	10	5,82
RF0137007010	3/4" x 1"	M / F	10	8,73
RF0137010012	1" x 1" 1/4	M / F	10	18,70

RF 260A

Gomito M-M/ Elbow M-M



Cod.	Size			€ / Cad.
RF0260A03000	3/8"	M / M	10	1,61
RF0260A05000	1/2"	M / M	10	2,62
RF0260A07000	3/4"	M / M	10	4,13
RF0260A10000	1"	M / M	10	7,60

clicca il seguente link: www.assotherm.it o scannerizza il QR-Code
per scaricare le schede tecniche dei prodotti



RF 270A

Nipplo M-M / Nipple M-M



Cod.	Size			€ / Cad.
RF0270A01000	1/8"	M / M	10	0,50
RF0270A02000	1/4"	M / M	10	0,70
RF0270A03000	3/8"	M / M	10	0,89
RF0270A05000	1/2"	M / M	10	1,12
RF0270A07000	3/4"	M / M	10	1,70
RF0270A10000	1"	M / M	10	2,92
RF0270A12000	1" 1/4	M / M	5	4,83
RF0270A15000	1" 1/2	M / M	5	6,66
RF0270A20000	2"	M / M	1	10,45

RF 287

Riduzione M-F / Reducing coupling M-F



Cod.	Size			€ / Cad.
RF0287002010	1/4" - 1/8"	M / F	10	0,47
RF0287003010	3/8" - 1/8"	M / F	10	0,78
RF0287003020	3/8" - 1/4"	M / F	10	0,95
RF0287005020	1/2" - 1/4"	M / F	10	1,15
RF0287005030	1/2" - 3/8"	M / F	10	0,89
RF0287007020	3/4" - 1/4"	M / F	10	2,54
RF0287007030	3/4" - 3/8"	M / F	10	1,76
RF0287007050	3/4" - 1/2"	M / F	10	1,15
RF0287010030	1" - 3/8"	M / F	10	3,21
RF0287010050	1" - 1/2"	M / F	10	2,62
RF0287010070	1" - 3/4"	M / F	5	1,89
RF0287012050	1" 1/4 - 1/2"	M / F	5	5,61
RF0287012070	1" 1/4 - 3/4"	M / F	1	5,17
RF0287012100	1" 1/4 - 1"	M / F	1	3,76
RF0287015050	1" 1/2 - 1/2"	M / F	1	8,08
RF0287015070	1" 1/2 - 3/4"	M / F	1	7,43
RF0287015100	1" 1/2 - 1"	M / F	1	6,26
RF0287015120	1" 1/2 - 1" 1/4	M / F	1	4,17
RF0287020100	2" - 1"	M / F	1	14,98
RF0287020120	2" - 1" 1/4	M / F	1	14,18
RF0287020150	2" - 1" 1/2	M / F	1	11,17

RF 291

Nipplo ridotto M-M / Reduced nipple M-M



Cod.	Size			€ / Cad.
RF0291005030	1/2" - 3/8"	M / M	10	1,18
RF0291007030	3/4" - 3/8"	M / M	10	2,31
RF0291007050	3/4" - 1/2"	M / M	10	1,70
RF0291010050	1" - 1/2"	M / M	10	3,07
RF0291010070	1" - 3/4"	M / M	10	2,82
RF0291012050	1" 1/4 - 1/2"	M / M	10	5,47
RF0291012070	1" 1/4 - 3/4"	M / M	5	5,50
RF0291012100	1" 1/4 - 1"	M / M	5	4,68
RF0291015070	1" 1/2 - 3/4"	M / M	1	7,81
RF0291015100	1" 1/2 - 1"	M / M	1	7,77
RF0291015120	1" 1/2 - 1" 1/4	M / M	1	8,22
RF0291020100	2" - 1"	M / M	1	13,31
RF0291020120	2" - 1" 1/4	M / M	1	12,96
RF0291020150	2" - 1" 1/2	M / M	1	11,87

clicca il seguente link: www.assotherm.it o scannerizza il QR-Code
per scaricare le schede tecniche dei prodotti



RF 286

Tappo M / Stop end M



Cod.	Size			€ / Cad.
RF0286001000	1/8"	M	10	0,49
RF0286002000	1/4"	M	10	0,56
RF0286003000	3/8"	M	10	0,74
RF0286005000	1/2"	M	10	0,79
RF0286007000	3/4"	M	10	1,50
RF0286010000	1"	M	10	2,34
RF0286012000	1" 1/4	M	5	4,83
RF0286015000	1" 1/2	M	5	6,18
RF0286020000	2"	M	1	9,47

RF 288

Tappo F / Stop end F



Cod.	Size			€ / Cad.
RF0288001000	1/8"	F	10	0,52
RF0288002000	1/4"	F	10	0,62
RF0288003000	3/8"	F	10	0,68
RF0288005000	1/2"	F	10	0,77
RF0288007000	3/4"	F	10	1,30
RF0288010000	1"	F	10	2,31
RF0288012000	1" 1/4	F	5	4,13
RF0288015000	1" 1/2	F	5	5,50
RF0288020000	2"	F	1	8,21

RF 270F

Manicotto F / Coupling F



Cod.	Size			€ / Cad.
RF0270F01000	1/8"	F	10	0,53
RF0270F02000	1/4"	F	10	0,68
RF0270F03000	3/8"	F	10	1,24
RF0270F05000	1/2"	F	10	1,70
RF0270F07000	3/4"	F	10	2,44
RF0270F10000	1"	F	10	3,74
RF0270F12000	1" 1/4	F	5	8,16
RF0270F15000	1" 1/2	F	5	10,38
RF0270F20000	2"	F	1	16,06

RF 180

Croce 4 vie F-F-F-F / Cross 4 ways F-F-F-F



Cod.	Size			€ / Cad.
RF0180000005	1/2"	F / F / F / F	1	5,92
RF0180000007	3/4"	F / F / F / F	1	9,22
RF0180000010	1"	F / F / F / F	1	15,59
RF0180000012	1" 1/4	F / F / F / F	1	25,14
RF0180000015	1" 1/2	F / F / F / F	1	35,39
RF0180020000	2"	F / F / F / F	1	50,94

clicca il seguente link: www.assotherm.it o scannerizza il QR-Code per scaricare le schede tecniche dei prodotti



RF 294

Manicotto ridotto F-F / Reducing coupling F-F



Cod.	Size			€ / Cad.
RF0294003020	3/8" - 1/4"	F / F	10	1,43
RF0294005030	1/2" - 3/8"	F / F	10	2,20
RF0294007050	3/4" - 1/2"	F / F	10	2,50
RF0294010050	1" - 1/2"	F / F	10	3,60
RF0294010070	1" - 3/4"	F / F	10	3,61
RF0294012050	1" 1/4 - 1/2"	F / F	5	6,66
RF0294012070	1" 1/4 - 3/4"	F / F	5	7,88
RF0294012100	1" 1/4 - 1"	F / F	1	6,66
RF0294015050	1" 1/2 - 1/2"	F / F	1	7,91
RF0294015070	1" 1/2 - 3/4"	F / F	1	7,91
RF0294015100	1" 1/2 - 1"	F / F	1	8,51
RF0294015120	1" 1/2 - 1" 1/4	F / F	1	9,70
RF0294020100	2" - 1"	F / F	1	12,80
RF0294020120	2" - 1" 1/4	F / F	1	14,21
RF0294020150	2" - 1" 1/2	F / F	1	14,11

RF 295

Manicotto ridotto F-M / Reducing coupling F-M



Cod.	Size			€ / Cad.
RF0295003020	3/8" - 1/4"	F / M	10	1,60
RF0295005020	1/2" - 1/4"	F / M	10	1,60
RF0295005030	1/2" - 3/8"	F / M	10	1,31
RF0295007050	3/4" - 1/2"	F / M	10	1,70
RF0295010050	1" - 1/2"	F / M	10	3,02
RF0295010070	1" - 3/4"	F / M	10	2,72
RF0295012050	1" 1/4 - 1/2"	F / M	10	5,35
RF0295012070	1" 1/4 - 3/4"	F / M	10	5,35
RF0295012100	1" 1/4 - 1"	F / M	5	4,26
RF0295015100	1" 1/2 - 1"	F / M	5	8,74
RF0295015120	1" 1/2 - 1" 1/4	F / M	1	7,80

RF 250F

Tee F-F-F / Tee F-F-F



Cod.	Size			€ / Cad.
RF0250F02000	1/4"	F / F / F	10	2,15
RF0250F03000	3/8"	F / F / F	10	2,43
RF0250F05000	1/2"	F / F / F	10	2,66
RF0250F07000	3/4"	F / F / F	10	4,45
RF0250F10000	1"	F / F / F	10	7,87
RF0250F12000	1" 1/4	F / F / F	5	14,95
RF0250F15000	1" 1/2	F / F / F	5	21,62
RF0250F20000	2"	F / F / F	1	28,33

RF 250A

Tee M-M-M / Tee M-M-M



Cod.	Size			€ / Cad.
RF0250A03000	3/8"	M / M / M	10	2,50
RF0250A05000	1/2"	M / M / M	10	3,14
RF0250A07000	3/4"	M / M / M	10	4,79
RF0250A10000	1"	M / M / M	10	8,13

clicca il seguente link: www.assotherm.it o scannerizza il QR-Code per scaricare le schede tecniche dei prodotti



RT 124

Raccordo dritto 3 pezzi, sede conica e o-ring F-F / Straight union taper seat o-ring F-F



Cod.	Size			€ / Cad.
RT0124000005	1/2"	F / F	10	5,83
RT0124000007	3/4"	F / F	10	8,30
RT0124000010	1"	F / F	10	12,06

RT 127

Raccordo dritto 3 pezzi, sede conica e o-ring M-M / Straight union taper seat o-ring M-M



Cod.	Size			€ / Cad.
RT0127003000	3/8"	M / M	10	3,12
RT0127005000	1/2"	M / M	10	4,24
RT0127007000	3/4"	M / M	10	7,28
RT0127010000	1"	M / M	10	11,48

RT 126

Raccordo dritto 3 pezzi, sede conica e o-ring M-F / Straight union taper seat o-ring M-F



Cod.	Size			€ / Cad.
RT0126003000	3/8"	M / F	10	3,41
RT0126005000	1/2"	M / F	10	3,58
RT0126007000	3/4"	M / F	10	5,18
RT0126010000	1"	M / F	10	8,30
RT0126012000	1" 1/4	M / F	5	13,02
RT0126015000	1" 1/2	M / F	5	20,71
RT0126020000	2"	M / F	5	36,77

RT 125

Raccordo curvo 3 pezzi, sede conica e o-ring M-F / Bent union taper seat o-ring M-F



Cod.	Size			€ / Cad.
RT0125003000	3/8"	M / F	10	3,95
RT0125005000	1/2"	M / F	10	4,70
RT0125007000	3/4"	M / F	10	7,06
RT0125010000	1"	M / F	10	11,48
RT0125012000	1" 1/4	M / F	5	18,46
RT0125015000	1" 1/2	M / F	5	32,02

clicca il seguente link: www.assotherm.it o scannerizza il QR-Code per scaricare le schede tecniche dei prodotti



RF 275L

Prolunga M-F / Extension M-F



Cod.	Size			€ / Cad.
RF0275L05010	1/2" - 10	M / F	10	1,46
RF0275L05015	1/2" - 15	M / F	10	1,83
RF0275L05020	1/2" - 20	M / F	10	2,15
RF0275L05025	1/2" - 25	M / F	10	2,54
RF0275L05030	1/2" - 30	M / F	10	2,74
RF0275L05040	1/2" - 40	M / F	10	3,44
RF0275L05050	1/2" - 50	M / F	10	4,24
RF0275L05060	1/2" - 60	M / F	10	5,21
RF0275L05080	1/2" - 80	M / F	10	6,34
RF0275L05100	1/2" - 100	M / F	10	8,10
RF0275L07010	3/4" - 10	M / F	10	2,13
RF0275L07015	3/4" - 15	M / F	10	2,62
RF0275L07020	3/4" - 20	M / F	10	3,08
RF0275L07025	3/4" - 25	M / F	10	3,41
RF0275L07030	3/4" - 30	M / F	10	3,80
RF0275L07040	3/4" - 40	M / F	10	4,69
RF0275L07050	3/4" - 50	M / F	10	5,28
RF0275L07060	3/4" - 60	M / F	10	6,07
RF0275L07080	3/4" - 80	M / F	10	8,21
RF0275L07100	3/4" - 100	M / F	10	9,23
RF0275L010010	1" - 10	M / F	10	3,59
RF0275L010015	1" - 15	M / F	10	4,19
RF0275L010020	1" - 20	M / F	10	4,88
RF0275L010025	1" - 25	M / F	10	5,57
RF0275L010030	1" - 30	M / F	10	6,04
RF0275L010040	1" - 40	M / F	10	7,42
RF0275L010050	1" - 50	M / F	10	8,39
RF0275L010060	1" - 60	M / F	10	11,41
RF0275L010080	1" - 80	M / F	10	14,40
RF0275L010100	1" - 100	M / F	10	17,46

clicca il seguente link: www.assotherm.it o scannerizza il QR-Code
per scaricare le schede tecniche dei prodotti



RACCORDI FILETTATI IN ACCIAIO INOX



Raccordi filettati in acciaio AISI 316L

AISI 316L steel threaded fittings

Materiale / Material : Acciaio Inox / Stainless Steel AISI 316 (1.4401)

Filettatura: UNI EN 10226-1 (ex iso 7/1)

Conformità / According to : EN 10204 3.1

RFX 240

Manicotto ridotto F-F / Reducing coupling F-F



Cod.	Size			€ / Cad.
RFX240000201	1/4" - 1/8"	F / F	10	4,19
RFX240000302	3/8" - 1/4"	F / F	10	4,17
RFX240000503	1/2" - 3/8"	F / F	10	4,82
RFX240000705	3/4" - 1/2"	F / F	10	5,94
RFX240001005	1" - 1/2"	F / F	10	7,59
RFX240001007	1" - 3/4"	F / F	10	9,62
RFX240001210	1" 1/4 - 1"	F / F	10	11,52
RFX240001510	1" 1/2 - 1"	F / F	10	16,66
RFX240001512	1" 1/2 - 1" 1/4	F / F	5	20,67
RFX240002012	2" - 1" 1/4	F / F	5	22,50
RFX240002015	2" - 1" 1/2	F / F	5	29,28
RFX240002520	2" 1/2 - 2"	F / F	5	40,61

RFX 290

Tappo M / Plug beaded M



Cod.	Size			€ / Cad.
RFX290000001	1/8"	M	10	1,22
RFX290000002	1/4"	M	10	1,37
RFX290000003	3/8"	M	10	1,89
RFX290000005	1/2"	M	10	2,11
RFX290000007	3/4"	M	10	3,12
RFX290000010	1"	M	5	4,73
RFX290000012	1" 1/4	M	5	6,66
RFX290000015	1" 1/2	M	5	8,76
RFX290000020	2"	M	1	13,78
RFX290000025	2" 1/2	M	1	20,67
RFX290000030	3"	M	1	33,79
RFX290000040	4"	M	1	58,89

RFX 270

Manicotto F-F / Coupling F-F



Cod.	Size			€ / Cad.
RFX270000001	1/8"	F / F	10	1,65
RFX270000002	1/4"	F / F	10	2,08
RFX270000003	3/8"	F / F	10	2,38
RFX270000005	1/2"	F / F	10	2,63
RFX270000007	3/4"	F / F	10	3,67
RFX270000010	1"	F / F	5	5,19
RFX270000012	1" 1/4	F / F	5	8,86
RFX270000015	1" 1/2	F / F	5	9,51
RFX270000020	2"	F / F	1	18,05
RFX270000025	2" 1/2	F / F	1	33,47
RFX270000030	3"	F / F	1	40,49
RFX270000040	4"	F / F	1	77,01

clicca il seguente link: www.assotherm.it o scannerizza il QR-Code
per scaricare le schede tecniche dei prodotti



RFX 280

Nipplo M-M / Nipple M-M



Cod.	Size			€ / Cad.
RFX280000001	1/8"	M / M	10	1,34
RFX280000002	1/4"	M / M	10	1,44
RFX280000003	3/8"	M / M	10	1,80
RFX280000005	1/2"	M / M	10	2,81
RFX280000007	3/4"	M / M	10	3,82
RFX280000010	1"	M / M	5	6,57
RFX280000012	1" 1/4	M / M	5	9,19
RFX280000015	1" 1/2	M / M	5	12,34
RFX280000020	2"	M / M	1	21,16
RFX280000025	2" 1/2	M / M	1	35,40
RFX280000030	3"	M / M	1	47,54
RFX280000040	4"	M / M	1	68,21

RFX 245

Nipplo ridotto M-M / Reducing nipple M-M



Cod.	Size			€ / Cad.
RFX245000201	1/4" - 1/8"	M / M	10	1,50
RFX245000302	3/8" - 1/4"	M / M	10	1,96
RFX245000501	1/2" - 1/8"	M / M	10	2,69
RFX245000502	1/2" - 1/4"	M / M	10	2,41
RFX245000503	1/2" - 3/8"	M / M	10	2,50
RFX245000702	3/4" - 1/4"	M / M	10	4,12
RFX245000705	3/4" - 1/2"	M / M	10	3,97
RFX245001005	1" - 1/2"	M / M	10	6,11
RFX245001007	1" - 3/4"	M / M	10	6,26
RFX245001205	1" 1/4 - 1/2"	M / M	10	8,86
RFX245001207	1" 1/4 - 3/4"	M / M	10	9,84
RFX245001210	1" 1/4 - 1"	M / M	5	9,51
RFX245001510	1" 1/2 - 1"	M / M	5	11,48
RFX245001512	1" 1/2 - 1" 1/4	M / M	1	11,81
RFX245002010	2" - 1"	M / M	1	17,39
RFX245002012	2" - 1" 1/4	M / M	1	18,05
RFX245002015	2" - 1" 1/2	M / M	1	17,72
RFX245002510	2" 1/2 - 1"	M / M	1	37,93
RFX245002512	2" 1/2 - 1" 1/4	M / M	1	37,86
RFX245002520	2" 1/2 - 2"	M / M	1	37,73
RFX245003025	3" - 2" 1/2	M / M	1	54,83

RFX 300

Tappo F / Stop end F



Cod.	Size			€ / Cad.
RFX300000001	1/8"	F	10	1,53
RFX300000002	1/4"	F	10	1,83
RFX300000003	3/8"	F	10	1,99
RFX300000005	1/2"	F	10	2,60
RFX300000007	3/4"	F	10	3,94
RFX300000010	1"	F	5	5,71
RFX300000012	1" 1/4	F	5	8,76
RFX300000015	1" 1/2	F	5	10,17
RFX300000020	2"	F	1	15,55
RFX300000025	2" 1/2	F	1	24,48
RFX300000030	3"	F	1	35,11
RFX300000040	4"	F	1	65,29

clicca il seguente link: www.assotherm.it o scannerizza il QR-Code per scaricare le schede tecniche dei prodotti



RFX 340

Bocchettone dritto F-F / Straight union F-F



Cod.	Size			€ / Cad.
RFX340000001	1/8"	F / F	10	5,04
RFX340000002	1/4"	F / F	10	6,41
RFX340000003	3/8"	F / F	10	7,64
RFX340000005	1/2"	F / F	10	7,61
RFX340000007	3/4"	F / F	10	10,39
RFX340000010	1"	F / F	5	15,58
RFX340000012	1" 1/4	F / F	5	23,95
RFX340000015	1" 1/2	F / F	5	34,12
RFX340000020	2"	F / F	1	45,28
RFX340000025	2" 1/2	F / F	1	75,14
RFX340000030	3"	F / F	1	101,71
RFX340000040	4"	F / F	1	163,89

RFX 341

Bocchettone dritto M-F / Straight union M-F



Cod.	Size			€ / Cad.
RFX341000001	1/8"	M / F	10	5,77
RFX341000002	1/4"	M / F	10	6,87
RFX341000003	3/8"	M / F	10	8,40
RFX341000005	1/2"	M / F	10	8,22
RFX341000007	3/4"	M / F	10	10,84
RFX341000010	1"	M / F	5	16,50
RFX341000012	1" 1/4	M / F	5	27,23
RFX341000015	1" 1/2	M / F	5	36,09
RFX341000020	2"	M / F	1	54,14
RFX341000025	2" 1/2	M / F	1	94,99
RFX341000030	3"	M / F	1	111,39
RFX341000040	4"	M / F	1	180,29

RFX 96

Bocchettone curvo, sede conica F-F / Bent union, taper seat F-F



Cod.	Size			€ / Cad.
RFX096000005	1/2"	F / F	10	12,22
RFX096000007	3/4"	F / F	10	15,98
RFX096000010	1"	F / F	5	21,51
RFX096000012	1" 1/4	F / F	5	35,30
RFX096000015	1" 1/2	F / F	5	40,29
RFX096000020	2"	F / F	1	63,39

RFX 98

Bocchettone curvo, sede conica M-F / Bent union, taper seat M-F



Cod.	Size			€ / Cad.
RFX098000005	1/2"	M / F	10	13,07
RFX098000007	3/4"	M / F	10	18,24
RFX098000010	1"	M / F	5	23,86
RFX098000012	1" 1/4	M / F	5	37,67
RFX098000015	1" 1/2	M / F	5	43,74
RFX098000020	2"	M / F	1	70,18

clicca il seguente link: www.assotherm.it o scannerizza il QR-Code per scaricare le schede tecniche dei prodotti



RFX 130

Tee F-F-F / Tee F-F-F



Cod.	Size			€ / Cad.
RFX130000001	1/8"	F / F / F	10	2,44
RFX130000002	1/4"	F / F / F	10	2,60
RFX130000003	3/8"	F / F / F	10	3,64
RFX130000005	1/2"	F / F / F	10	4,67
RFX130000007	3/4"	F / F / F	10	7,09
RFX130000010	1"	F / F / F	5	9,93
RFX130000012	1" 1/4	F / F / F	5	15,95
RFX130000015	1" 1/2	F / F / F	5	20,97
RFX130000020	2"	F / F / F	1	31,14
RFX130000025	2" 1/2	F / F / F	1	67,26
RFX130000030	3"	F / F / F	1	94,82
RFX130000040	4"	F / F / F	1	162,51

RFX 180

Croce F-F-F-F / Cross fitting F-F-F-F



Cod.	Size			€ / Cad.
RFX180000001	1/8"	F / F / F / F	10	7,21
RFX180000002	1/4"	F / F / F / F	10	4,09
RFX180000003	3/8"	F / F / F / F	10	5,19
RFX180000005	1/2"	F / F / F / F	10	6,78
RFX180000007	3/4"	F / F / F / F	10	12,10
RFX180000010	1"	F / F / F / F	5	15,73
RFX180000012	1" 1/4	F / F / F / F	5	26,90
RFX180000015	1" 1/2	F / F / F / F	5	32,65
RFX180000020	2"	F / F / F / F	1	49,05
RFX180000025	2" 1/2	F / F / F / F	1	105,58
RFX180000030	3"	F / F / F / F	1	149,45
RFX180000040	4"	F / F / F / F	1	251,06

RFX 310

Controdado / Locknut



Cod.	Size			€ / Cad.
RFX310000001	1/8"		10	1,63
RFX310000002	1/4"		10	1,66
RFX310000003	3/8"		10	1,76
RFX310000005	1/2"		10	1,84
RFX310000007	3/4"		10	2,34
RFX310000010	1"		5	2,86
RFX310000012	1" 1/4		5	4,30
RFX310000015	1" 1/2		5	5,75
RFX310000020	2"		1	8,52
RFX310000025	2" 1/2		1	23,49
RFX310000030	3"		1	28,77
RFX310000040	4"		1	42,29

clicca il seguente link: www.assotherm.it o scannerizza il QR-Code per scaricare le schede tecniche dei prodotti



RFX 90

Gomito F-F / Elbow F-F



Cod.	Size			€ / Cad.
RFX090000001	1/8"	F / F	10	1,53
RFX090000002	1/4"	F / F	10	1,89
RFX090000003	3/8"	F / F	10	2,54
RFX090000005	1/2"	F / F	10	3,30
RFX090000007	3/4"	F / F	10	4,89
RFX090000010	1"	F / F	5	7,64
RFX090000012	1" 1/4	F / F	5	12,47
RFX090000015	1" 1/2	F / F	5	16,14
RFX090000020	2"	F / F	1	24,94
RFX090000025	2" 1/2	F / F	1	48,56
RFX090000030	3"	F / F	1	74,81
RFX090000040	4"	F / F	1	136,79

RFX 92

Gomito M-F / Elbow M-F



Cod.	Size			€ / Cad.
RFX092000001	1/8"	M / F	10	1,83
RFX092000002	1/4"	M / F	10	2,50
RFX092000003	3/8"	M / F	10	2,96
RFX092000005	1/2"	M / F	10	3,94
RFX092000007	3/4"	M / F	10	5,16
RFX092000010	1"	M / F	5	7,94
RFX092000012	1" 1/4	M / F	5	13,09
RFX092000015	1" 1/2	M / F	5	17,06
RFX092000020	2"	M / F	1	25,66
RFX092000025	2" 1/2	M / F	1	52,17
RFX092000030	3"	M / F	1	79,89
RFX092000040	4"	M / F	1	138,46

RFX 120

Gomito 45° F-F / Elbow 45° F-F



Cod.	Size			€ / Cad.
RFX120000002	1/4"	F / F	10	3,49
RFX120000003	3/8"	F / F	10	3,63
RFX120000005	1/2"	F / F	10	4,09
RFX120000007	3/4"	F / F	10	5,54
RFX120000010	1"	F / F	5	9,42
RFX120000012	1" 1/4	F / F	5	14,98
RFX120000015	1" 1/2	F / F	5	19,83
RFX120000020	2"	F / F	1	27,73
RFX120000025	2" 1/2	F / F	1	77,71
RFX120000030	3"	F / F	1	93,76

RFX 531

Raccordo tutto filettato / Full threaded fitting



Cod.	Size			€ / Cad.
RFX531000002	1/4"		10	1,92
RFX531000003	3/8"		10	2,10
RFX531000005	1/2"		10	2,53
RFX531000007	3/4"		10	3,61
RFX531000010	1"		5	5,24
RFX531000012	1" 1/4		5	5,76
RFX531000015	1" 1/2		5	6,11
RFX531000020	2"		1	10,47
RFX531000030	3"		1	a richiesta / on demand

clicca il seguente link: www.assotherm.it o scannerizza il QR-Code per scaricare le schede tecniche dei prodotti



RFX 121

Gomito 45° M-F / Elbow 45° M-F



Cod.	Size			€ / Cad.
RFX121000002	1/4"	M / F	10	3,23
RFX121000003	3/8"	M / F	10	4,18
RFX121000005	1/2"	M / F	10	5,70
RFX121000007	3/4"	M / F	10	7,45
RFX121000010	1"	M / F	5	12,27
RFX121000012	1" 1/4	M / F	5	19,55
RFX121000015	1" 1/2	M / F	5	25,42
RFX121000020	2"	M / F	1	37,18
RFX121000025	2" 1/2	M / F	1	86,05
RFX121000030	3"	M / F	1	109,45

RFX 241

Riduzione M-F / Reducing coupling M-F



Cod.	Size			€ / Cad.
RFX241000201	1/4" - 1/8"	M / F	10	1,47
RFX241000301	3/8" - 1/8"	M / F	10	1,68
RFX241000302	3/8" - 1/4"	M / F	10	1,77
RFX241000501	1/2" - 1/8"	M / F	10	2,87
RFX241000502	1/2" - 1/4"	M / F	10	2,23
RFX241000503	1/2" - 3/8"	M / F	10	2,05
RFX241000702	3/4" - 1/4"	M / F	10	3,70
RFX241000703	3/4" - 3/8"	M / F	10	3,24
RFX241000705	3/4" - 1/2"	M / F	10	2,90
RFX241001005	1" - 1/2"	M / F	10	5,13
RFX241001007	1" - 3/4"	M / F	10	4,73
RFX241001205	1" 1/4 - 1/2"	M / F	10	8,83
RFX241001207	1" 1/4 - 3/4"	M / F	5	8,89
RFX241001210	1" 1/4 - 1"	M / F	5	8,17
RFX241001505	1" 1/2 - 1/2"	M / F	5	10,37
RFX241001507	1" 1/2 - 3/4"	M / F	5	11,16
RFX241001510	1" 1/2 - 1"	M / F	5	11,22
RFX241001512	1" 1/2 - 1" 1/4	M / F	5	9,51
RFX241002007	2" - 3/4"	M / F	1	19,94
RFX241002010	2" - 1"	M / F	1	17,39
RFX241002012	2" - 1" 1/4	M / F	1	17,06
RFX241002015	2" - 1" 1/2	M / F	1	15,42
RFX241002510	2" 1/2 - 1"	M / F	1	39,08
RFX241002512	2" 1/2 - 1" 1/4	M / F	1	31,46
RFX241002515	2" 1/2 - 1" 1/2	M / F	1	29,20
RFX241002520	2" 1/2 - 2"	M / F	1	26,25
RFX241003020	3" - 2"	M / F	1	35,93
RFX241003025	3" - 2" 1/2	M / F	1	32,65
RFX241004030	4" - 3"	M / F	1	60,47

clicca il seguente link: www.assotherm.it o scannerizza il QR-Code per scaricare le schede tecniche dei prodotti



RACCORDI A STRINGERE PER TUBO POLIETILENE



Raccordi a stringere per tubo polietilene**Compression fittings for polyethylene pipe**

Materiale / Material : Ottone / Brass (CW617N UNI EN 12165)

Temperatura d'esercizio / Operating temperature : 0 ↔ +85 °C

Pressione nominale / Nominal pressure: PN 10

RP 350

Tee a stringere / Compression Tee



Cod.	Size		€ / Cad.
RP0350002000	20	10	10,75
RP0350002500	25	10	14,20
RP0350003200	32	5	21,64
RP0350004000	40	3	33,60
RP0350005000	50	2	59,23
RP0350006300	63	1	86,77

RP 352

Tee uscita filetto femmina / Female compression Tee



Cod.	Size		€ / Cad.
RP0352005200	1/2" - 20	10	9,31
RP0352007250	3/4" - 25	10	11,39
RP0352010320	1" - 32	5	18,15
RP0352012400	1" 1/4 - 40	3	27,14
RP0352015500	1" 1/2 - 50	2	48,04
RP0352020630	2" - 63	1	77,65

RP 360

Curva a stringere / Compression elbow



Cod.	Size		€ / Cad.
RP0360000200	20	10	7,92
RP0360000250	25	10	10,12
RP0360000320	32	5	15,04
RP0360000400	40	3	24,02
RP0360000500	50	2	37,55
RP0360000630	63	1	60,67

RP 361

Curva uscita filetto maschio / Male compression elbow



Cod.	Size		€ / Cad.
RP0361005200	1/2" - 20	10	4,82
RP0361007250	3/4" - 25	10	6,50
RP0361010320	1" - 32	5	9,85
RP0361012400	1" 1/4 - 40	3	17,42
RP0361015500	1" 1/2 - 50	2	28,71
RP0361020630	2" - 63	1	48,51

RP 362

Curva uscita filetto femmina / Female compression elbow



Cod.	Size		€ / Cad.
RP0362005200	1/2" - 20	10	5,26
RP0362007250	3/4" - 25	10	6,97
RP0362010320	1" - 32	5	11,02
RP0362012400	1" 1/4 - 40	3	18,16
RP0362015500	1" 1/2 - 50	2	29,55
RP0362020630	2" - 63	1	42,88

clicca il seguente link: www.assotherm.it o scannerizza il QR-Code per scaricare le schede tecniche dei prodotti



RP 363

Gomito con base, uscita filetto femmina / Wall plate compression elbow



Cod.	Size		€ / Cad.
RP0363005200	1/2" - 20	10	6,97
RP0363007250	3/4" - 25	10	9,41
RP0363010320	1" - 32	5	13,60

RP 370

Manicotto a stringere / Compression coupling



Cod.	Size		€ / Cad.
RP0370000200	20	10	6,63
RP0370000250	25	10	8,54
RP0370000320	32	5	12,63
RP0370000400	40	3	18,73
RP0370000500	50	2	29,21
RP0370000630	63	1	52,96

RP 370L

Manicotto lungo a stringere / Compression coupling long pattern



Cod.	Size		€ / Cad.
RP0370L02000	20	10	6,70
RP0370L02500	25	10	9,61
RP0370L03200	32	5	16,31
RP0370L04000	40	3	23,25
RP0370L05000	50	2	33,37
RP0370L06300	63	1	53,13

RP 371

Raccordo dritto uscita filetto maschio / Male compression coupling



Cod.	Size		€ / Cad.
RP0371005200	1/2" - 20	10	4,02
RP0371007250	3/4" - 25	10	5,19
RP0371010320	1" - 32	5	7,71
RP0371012400	1" 1/4 - 40	3	12,70
RP0371015500	1" 1/2 - 50	2	17,89
RP0371020630	2" - 63	1	30,02

RP 380

Raccordo dritto uscita filetto femmina / Female compression coupling



Cod.	Size		€ / Cad.
RP0380005200	1/2" - 20	10	3,89
RP0380007250	3/4" - 25	10	5,56
RP0380010320	1" - 32	5	7,77
RP0380012400	1" 1/4 - 40	3	13,97
RP0380015500	1" 1/2 - 50	2	18,79
RP0380020630	2" - 63	1	31,56

clicca il seguente link: www.assotherm.it o scannerizza il QR-Code per scaricare le schede tecniche dei prodotti



RP 390

Raccordo dritto uscita filetto femmina con flangia / Flanged straight female coupling



Cod.	Size		€ / Cad.
RP0390025750	2" 1/2 - 75	10	111,45
RP0390030900	3" - 90	10	185,79
RP0390040110	4" - 110	5	302,40

RP 391

Raccordo dritto uscita filetto maschio con flangia / Flanged straight male coupling



Cod.	Size		€ / Cad.
RP0391025750	2" 1/2 - 75	10	97,00
RP0391030900	3" - 90	10	180,43
RP0391040110	4" - 110	5	295,27

clicca il seguente link: www.assotherm.it o scannerizza il QR-Code
per scaricare le schede tecniche dei prodotti



RACCORDI A STRINGERE PER TUBO RAME BICONO





Raccordi a stringere per tubo rame bicono



Compression fittings for copper pipe

Materiale / Material : Ottone / Brass (CW617N/CW612N - UNI EN 12165)

Pressione nominale / Nominal pressure: PN 16

Temperatura d'esercizio / Operating temperature : -20 ↔ +120 °C

RB 271

Raccordo dritto uscita filetto Maschio a stringere / Male compression coupling



Cod.	Size		€ / Cad.
RB0271003120	3/8" - 12	10	2,40
RB0271003150	3/8" - 15	10	3,56
RB0271005120	1/2" - 12	10	3,08
RB0271005140	1/2" - 14	10	3,97
RB0271005150	1/2" - 15	10	3,96
RB0271005160	1/2" - 16	10	4,59
RB0271005180	1/2" - 18	10	4,72
RB0271007180	3/4" - 18	10	5,69
RB0271007220	3/4" - 22	10	6,34
RB0271010220	1" - 22	10	8,89
RB0271010280	1" - 28	10	10,57
RB0271012350	1" 1/4 - 35	5	19,01

RB 280

Raccordo dritto uscita filetto Femmina a stringere / Female compression coupling



Cod.	Size		€ / Cad.
RB0280003120	3/8" - 12	10	2,85
RB0280003150	3/8" - 15	10	4,00
RB0280005120	1/2" - 12	10	3,96
RB0280005140	1/2" - 14	10	4,66
RB0280005150	1/2" - 15	10	4,18
RB0280005160	1/2" - 16	10	5,48
RB0280005180	1/2" - 18	10	4,70
RB0280007180	3/4" - 18	10	6,74
RB0280007220	3/4" - 22	10	7,55
RB0280010220	1" - 22	10	10,41
RB0280010280	1" - 28	10	11,13
RB0280012350	1" 1/4 - 35	5	19,55

RB 250

Tee a stringere bicono / Compression Tee



Cod.	Size		€ / Cad.
RB0250000120	12	10	6,12
RB0250000140	14	10	10,00
RB0250000150	15	10	10,00
RB0250000160	16	10	10,05
RB0250000180	18	10	9,76
RB0250000220	22	10	12,00
RB0250000280	28	10	22,00
RB0250000350	35	5	21,03

clicca il seguente link: www.assotherm.it o scannerizza il QR-Code per scaricare le schede tecniche dei prodotti



RB 260

Curva a stringere bicono / Compression elbow



Cod.	Size		€ / Cad.
RB0260000120	12	10	4,28
RB0260000140	14	10	6,36
RB0260000150	15	10	5,67
RB0260000160	16	10	8,39
RB0260000180	18	10	7,90
RB0260000220	22	10	9,11
RB0260000280	28	10	14,24
RB0260000350	35	5	25,61

RB 261

Curva uscita filetto maschio a stringere bicono / Male compression elbow



Cod.	Size		€ / Cad.
RB0261003120	3/8" - 12	10	4,09
RB0261005120	1/2" - 12	10	5,67
RB0261005140	1/2" - 14	10	5,60
RB0261005150	1/2" - 15	10	5,40
RB0261005160	1/2" - 16	10	6,56
RB0261007180	3/4" - 18	10	7,36
RB0261007220	3/4" - 22	10	8,41
RB0261010220	1" - 22	10	12,57
RB0261010280	1" - 28	5	14,26

RB 262

Curva uscita filetto femmina a stringere bicono / Female compression elbow



Cod.	Size		€ / Cad.
RB0262003120	3/8" - 12	10	4,96
RB0262005120	1/2" - 12	10	4,43
RB0262005140	1/2" - 14	10	5,05
RB0262005150	1/2" - 15	10	6,71
RB0262005160	1/2" - 16	10	6,76
RB0262007180	3/4" - 18	10	7,88
RB0262007220	3/4" - 22	10	8,04
RB0262010220	1" - 22	10	10,94
RB0262010280	1" - 28	5	13,35

clicca il seguente link: www.assotherm.it o scannerizza il QR-Code
per scaricare le schede tecniche dei prodotti



RB 270

Manicotto a stringere bicono / Compression coupling



Cod.	Size		€ / Cad.
RB0270000120	12	10	3,52
RB0270000140	14	10	5,39
RB0270000150	15	10	5,13
RB0270000160	16	10	6,52
RB0270000180	18	10	6,34
RB0270000220	22	10	8,22
RB0270000280	28	10	11,71
RB0270000350	35	5	25,45

RB 270R

Manicotto ridotto a stringere bicono / Compression coupling reduced



Cod.	Size		€ / Cad.
RB0270R01512	15 - 12	10	4,31
RB0270R02215	22 - 15	10	7,90
RB0270R02822	28 - 22	10	11,22
RB0270R03515	35 - 15	10	a richiesta / on demand
RB0270R03522	35 - 22	10	a richiesta / on demand

clicca il seguente link: www.assotherm.it o scannerizza il QR-Code per scaricare le schede tecniche dei prodotti



RACCORDI A SALDARE IN ACCIAIO AL CARBONIO



**RS 260S**

Curva acciaio a saldare (con saldatura) / Soldering elbow (welded pattern)



Cod.	Size		€ / Cad.
RS0260S00700	26,9	20	2,65
RS0260S01000	33,7	20	2,40
RS0260S01200	42,4	20	3,10
RS0260S01500	48,3	10	3,60
RS0260S02000	60,3	10	5,89
RS0260S02500	76,1	5	9,10
RS0260S03000	88,9	2	12,35
RS0260S04000	114,3	1	26,35
RS0260S05000	139,7	1	44,61
RS0260S06000	168,3	1	66,44
RS0260S08000	219,1	1	165,00

→ X versione senza saldatura indicare Cod. RS260.... / For version without soldering indicate Cod. RS260...

RS 294

Riduzione concentrica nera a saldare / Concentric reducer



Cod.	Size		€ / Cad.
RS0294010070	33,7 - 26,9	20	5,45
RS0294012070	42,4 - 26,9	20	5,90
RS0294012100	42,4 - 33,7	10	5,70
RS0294015070	48,3 - 26,9	10	8,50
RS0294015100	48,3 - 33,7	10	6,89
RS0294015120	48,3 - 42,4	5	5,90
RS0294020100	60,3 - 33,7	5	8,60
RS0294020120	60,3 - 42,4	5	8,40
RS0294020150	60,3 - 48,3	1	6,90
RS0294025120	76,1 - 42,4	1	10,50
RS0294025150	76,1 - 48,3	1	9,50
RS0294025200	76,1 - 60,3	1	8,90
RS0294030150	88,9 - 48,3	1	15,20
RS0294030200	88,9 - 60,3	1	12,00
RS0294030250	88,9 - 76,1	1	10,50
RS0294040200	114,3 - 60,3	1	24,20
RS0294040250	114,3 - 76,1	1	20,00
RS0294040300	114,3 - 88,9	1	17,80
RS0294050250	139,7 - 76,1	1	42,60
RS0294050300	139,7 - 88,9	1	39,80
RS0294050400	139,7 - 114,3	1	28,90
RS0294060300	168,3 - 88,9	1	63,90
RS0294060400	168,3 - 114,3	1	44,70
RS0294060500	168,3 - 139,7	1	41,56
RS0294080400	219,1 - 114,3	1	95,90
RS0294080500	219,1 - 139,7	1	87,50
RS0294080600	219,1 - 168,3	1	69,00

clicca il seguente link: www.assotherm.it o scannerizza il QR-Code
per scaricare le schede tecniche dei prodotti



RS 288

Fondo bombato nero saldare / Convex cap



Cod.	Size		€ / Cad.
RS0288001000	33,7	30	1,50
RS0288001200	42,4	20	1,65
RS0288001500	48,3	20	1,85
RS0288002000	60,3	10	2,12
RS0288002500	76,1	10	3,40
RS0288003000	88,9	5	4,20
RS0288004000	114,3	2	11,17
RS0288005000	139,7	1	18,50
RS0288006000	168,3	1	31,73
RS0288008000	219,1	1	61,00
RS0288010000	273,0	1	120,00

RS 270F

Manicotto nero saldare / Soldering coupling



Cod.	Size		€ / Cad.
RS0270F00500	1/2"	30	1,20
RS0270F00700	3/4"	20	1,50
RS0270F01000	1"	20	2,15
RS0270F01200	1" 1/4	10	3,28
RS0270F01500	1" 1/2	10	3,80
RS0270F02000	2"	5	5,90
RS0270F02500	2" 1/2	2	10,15
RS0270F03000	3"	1	12,45

RS 250

Tee a saldare / Soldering Tee



Cod.	Size		€ / Cad.
RS0250000700	26,9	20	12,45
RS0250001000	33,7	20	14,90
RS0250001200	42,4	20	17,60
RS0250001500	48,3	10	18,47
RS0250002000	60,3	10	25,80
RS0250002500	76,1	5	40,00
RS0250003000	88,9	2	56,00
RS0250004000	114,3	1	75,00
RS0250005000	139,7	1	105,90
RS0250006000	168,3	1	165,89
RS0250008000	219,1	1	389,45

clicca il seguente link: www.assotherm.it o scannerizza il QR-Code
per scaricare le schede tecniche dei prodotti



RACCORDI A SALDARE PER TUBO INOX 304L



RSX 250

Tee a saldare INOX 304L sp.02 / Soldering elbow INOX 304L sp.02



Cod.	Size		€ / Cad.
RSX250000500	21,3 x 2	20	12,60
RSX250000700	26,9 x 2	20	13,13
RSX250001000	33,7 x 2	20	14,14
RSX250001200	42,4 x 2	20	16,38
RSX250001500	48,3 x 2	10	18,31
RSX250002000	60,3 x 2	10	27,48
RSX250002500	76,1 x 2	5	37,47
RSX250003000	88,9 x 2	2	48,69
RSX250004000	114,3 x 2	1	59,36
RSX250005000	139,7 x 2	1	127,91
RSX250006000	168,3 x 2	1	168,91
RSX250008000	219,1 x 2	1	315,83
RSX250010000	273,0 x 2	1	612,07
RSX250012000	323,9 x 2	1	1056,04

RSX 260

Curva a saldare INOX 304L sp.02 / Soldering Tee INOX 304L sp.02



Cod.	Size		€ / Cad.
RSX260000500	21,3 x 2	20	5,01
RSX260000700	26,9 x 2	20	5,29
RSX260001000	33,7 x 2	20	5,74
RSX260001200	42,4 x 2	20	7,04
RSX260001500	48,3 x 2	10	8,30
RSX260002000	60,3 x 2	10	12,04
RSX260002500	76,1 x 2	5	19,55
RSX260003000	88,9 x 2	2	24,65
RSX260004000	114,3 x 2	1	36,14
RSX260005000	139,7 x 2	1	73,37
RSX260006000	168,3 x 2	1	100,67
RSX260008000	219,1 x 2	1	175,07
RSX260010000	273,0 x 2	1	402,93
RSX260012000	323,9 x 2	1	646,24

RSX 270F

Manicotto a saldare INOX 304L / Soldering coupling INOX 304L



Cod.	Size		€ / Cad.
RSX270F00500	1/2"	10	6,09
RSX270F00700	3/4"	10	7,91
RSX270F01000	1"	10	12,29
RSX270F01200	1" 1/4	10	19,93
RSX270F01500	1" 1/2	10	23,49

clicca il seguente link: www.assotherm.it o scannerizza il QR-Code per scaricare le schede tecniche dei prodotti



RSX 288

Fondo bombato a saldare INOX 304L sp.02 / Soldering convex cap INOX 304L sp.02





Cod.	Size		€ / Cad.
RSX288000500	21,3 x 2	20	2,07
RSX288000700	26,9 x 2	20	2,14
RSX288001000	33,7 x 2	20	2,87
RSX288001200	42,4 x 2	20	3,75
RSX288001500	48,3 x 2	10	4,38
RSX288002000	60,3 x 2	10	5,50
RSX288002500	76,1 x 2	5	7,77
RSX288003000	88,9 x 2	2	9,84
RSX288004000	114,3 x 2	1	13,34
RSX288005000	139,7 x 2	1	17,15
RSX288006000	168,3 x 2	1	26,99
RSX288008000	219,1 x 2	1	44,52
RSX288010000	273,0 x 2	1	64,65
RSX288012000	323,9 x 2	1	88,45

RSX 294

Riduzione concentrica INOX 304L sp.02 / Concentric reducer INOX 304L sp.02



Cod.	Size		€ / Cad.	Cod.	Size		€ / Cad.
RSX294010070	33,7 - 26,9	20	6,48	RSX294030250	88,9 - 76,1	1	18,12
RSX294012070	42,4 - 26,9	20	9,35	RSX294040200	114,3 - 60,3	1	27,13
RSX294012100	42,4 - 33,7	10	8,08	RSX294040250	114,3 - 76,1	1	22,92
RSX294015070	48,3 - 26,9	10	12,25	RSX294040300	114,3 - 88,9	1	22,20
RSX294015100	48,3 - 33,7	10	11,69	RSX294050250	139,7 - 76,1	1	57,12
RSX294015120	48,3 - 42,4	5	10,61	RSX294050300	139,7 - 88,9	1	49,95
RSX294020100	60,3 - 33,7	5	14,28	RSX294050400	139,7 - 114,3	1	47,43
RSX294020120	60,3 - 42,4	5	13,20	RSX294060300	168,3 - 88,9	1	74,60
RSX294020150	60,3 - 48,3	1	12,15	RSX294060400	168,3 - 114,3	1	63,00
RSX294025120	76,1 - 42,4	1	21,62	RSX294060500	168,3 - 139,7	1	56,92
RSX294025150	76,1 - 48,3	1	17,65	RSX294080400	219,1 - 114,3	1	114,72
RSX294025200	76,1 - 60,3	1	16,39	RSX294080500	219,1 - 139,7	1	101,76
RSX294030150	88,9 - 48,3	1	20,64	RSX294080600	219,1 - 168,3	1	90,00
RSX294030200	88,9 - 60,3	1	19,14				

RSX 529

Tronchetto a saldare INOX 304L / Welding nipple INOX 304L



Cod.	Size		€ / Cad.
RSX529001010	1/8"	10	3,27
RSX529002013	1/4"	10	3,36
RSX529003017	3/8"	10	3,47
RSX529005021	1/2"	10	4,18
RSX529007026	3/4"	10	5,55
RSX529010037	1"	10	6,55
RSX529012042	1" 1/4	10	9,64
RSX529015048	1" 1/2	10	10,83
RSX529020060	2"	1	14,84
RSX529025076	2" 1/2	1	37,94
RSX529030088	3"	1	57,61
RSX529040114	4"	1	112,02

clicca il seguente link: www.assotherm.it o scannerizza il QR-Code per scaricare le schede tecniche dei prodotti



TUBAZIONI PER SISTEMI A SALDARE E FILETTARE

 Tubazioni per sistemi a saldare e filettare

 Soldering and threading pipes

→ Prezzi netti periodici / Periodic net prices

TLCVR

Tubo acciaio al carbonio verniciato rosso / Carbon steel pipe red painted



Cod.	Size		€ / Cad.
TLCVR000017,2	17,2 X 2,0	6 m	
TLCVR000021,3	21,3 X 2,3	6 m	
TLCVR000026,9	26,9 X 2,3	6 m	
TLCVR000033,7	33,7 X 2,9	6 m	
TLCVR000042,4	42,4 X 2,9	6 m	
TLCVR000048,3	48,3 X 2,9	6 m	
TLCVR000060,3	60,3 X 3,2	6 m	
TLCVR000076,1	76,1 X 3,2	6 m	
TLCVR000088,9	88,9 X 3,6	6 m	
TLCVR000114,3	114,3 X 4,0	6 m	
TLCVR000139,7	139,7 X 3,6	6 m	
TLCVR000168,3	168,3 X 4,0	6 m	
TLCVR000219,1	219,1 X 5,0	6 m	
TLCVR000273,0	273,0 X 5,6	6 m	

TLCZVM

Tubo acciaio al carbonio galvanizzato vite-manicotto / Galvanized carbon steel pipe



Cod.	Size		€ / Cad.
TLCZVM000003	3/8" X 2	6 m	
TLCZVM000005	1/2" X 2,3	6 m	
TLCZVM000007	3/4" X 2,3	6 m	
TLCZVM000010	1" X 2,9	6 m	
TLCZVM000012	1"1/4 X 2,9	6 m	
TLCZVM000015	1"1/2 X 2,9	6 m	
TLCZVM000020	2" X 3,2	6 m	
TLCZVM000025	2"1/2 X 3,2	6 m	
TLCZVM000030	3" X 3,6	6 m	
TLCZVM000040	4" X 4	6 m	

clicca il seguente link: www.assotherm.it o scannerizza il QR-Code
per scaricare le schede tecniche dei prodotti



RACCORDI PORTAGOMMA E PER CASSONE





Raccordi portagomma



Hose fast connectors

Materiale / Material : Ottone giallo / Yellow brass

Filettatura / Threads : UNI EN 10226-1 (ex iso 7/1)

Conformità: DM 174 06/04/2004

SPB 277

Raccordo portagomma uscita filetto maschio / Male hose connector



Cod.	Size		€ / Cad.
SPB277000314	3/8" - 14	10	2,70
SPB277000514	1/2" - 14	10	3,00
SPB277000518	1/2" - 18	10	3,00
SPB277000520	1/2" - 20	10	3,00
SPB277000720	3/4" - 20	10	5,15
SPB277000725	3/4" - 25	10	5,15
SPB277001020	1" - 20	10	7,30
SPB277001025	1" - 25	10	7,23
SPB277001030	1" - 30	10	7,33

SPB 278

Raccordo portagomma uscita filetto femmina / Female hose connector



Cod.	Size		€ / Cad.
SPB278000310	3/8" - 10	10	3,00
SPB278000314	3/8" - 14	10	3,00
SPB278000510	1/2" - 10	10	3,61
SPB278000512	1/2" - 12	10	3,61
SPB278000514	1/2" - 14	10	3,61
SPB278000520	1/2" - 20	10	3,61
SPB278000720	3/4" - 20	10	4,65
SPB278001025	1" - 25	10	7,22

clicca il seguente link: www.assotherm.it o scannerizza il QR-Code per scaricare le schede tecniche dei prodotti



ACCESSORI PER RACCORDERIE



**LOCTITE FILO**

Loctite filo



Cod.	Size		€ / Cad.
VV00FILO0150	150mt	1	35,64

PTFE VAPORE

Rotolo PTFE HD rosa alte pressioni / Pink high pressure teflon tape (steam, thermal oil, ...)



Cod.	Size		€ / Cad.
VV00VIKY7100	h12 - sp.0,10 - 12mt	10	2,75
VV00VIKY7200	h19 - sp.0,10 - 12mt	10	4,06

PTFE IDRAULICA

Rotolo PTFE / PTFE tape



Cod.	Size		€ / Cad.
VV00VIKY6300	h12 - sp.0,075 - 12mt	10	1,30
VV00VIKY6400	h12 - sp.0,075 - 25mt	10	2,01

PTFE PROFESSIONALE

Rotolo PTFE alte pressioni / High pressure teflon tape



Cod.	Size		€ / Cad.	
VV00VIKY6800	h12 - sp.0,20 - 15mt	10	2,43	
VV00VIKY6900	h19 - sp.0,20 - 15mt	10	3,12	
VV00VIKY6700	h19 - sp.0,10 - 12mt	GAS	10	1,30

CANAPA

Canapa per giunzioni / Hemp



Cod.	Size		€ / Cad.
VV00CANAPAC1	250 gr	1	5,80

clicca il seguente link: www.assotherm.it o scannerizza il QR-Code per scaricare le schede tecniche dei prodotti



MUTAPPO

Tappo per prova impianto / Cap for system testing



Cod.	Size		€ / Cad.
MUTAPPO_B05	1/2" BLU	1	1,30
MUTAPPO_R05	1/2" ROSSO	1	1,30

PASTA

Pasta per tenuta filetti / Green paste for threads



Cod.	Size		€ / Cad.
VV00VIK14000	450 gr	1	7,02

GFIB

Guarnizione FASIT verde / Fiber O-ring



Cod.	Size		€ / Cad.
VV00GFIB0003	3/8"	100	2,13
VV00GFIB0005	1/2"	100	3,06
VV00GFIB0007	3/4"	100	3,59
VV00GFIB0010	1"	100	5,05
VV00GFIB0012	1" 1/4	100	9,71
VV00GFIB0015	1" 1/2	100	14,36
VV00GFIB0020	2"	100	22,34

SILICONE

Silicone



Cod.	Size		€ / Cad.
VV00SILTRASP	Trasparente	10	9,00
VV00SILGRIGIO	Grigio	10	900
VV00SILALLUM	Alluminio	10	9,00

clicca il seguente link: www.assotherm.it o scannerizza il QR-Code
per scaricare le schede tecniche dei prodotti



VS 150 GAS

Raccordo flessibile estensibile UNIGAS acciaio inox 321L M/F / Stainless steel 321L UNIGAS extensible joint M/F



Cod.	Size			€ / Cad.
VS0150050200	1/2"	100-200	18	10,51
VS0150050400	1/2"	200-400	18	11,89
VS0150050480	1/2"	260-480	18	13,25
VS0150070200	3/4"	100-200	18	16,10
VS0150070400	3/4"	200-400	18	18,59
VS0150070480	3/4"	260-480	18	19,28
VS0150507130	1/2" - 3/4"	75 - 130	18	15,47
VS0150507200	1/2" - 3/4"	100-200	18	16,10
VS0150507400	1/2" - 3/4"	200-400	18	18,59
VS0150507480	1/2" - 3/4"	260-480	18	19,28
VS0150100200	1"	100-200	18	19,88
VS0150100400	1"	200-400	18	25,84
VS0150100480	1"	260-480	18	29,26

VS 160 ACQUA

Raccordo flessibile estensibile ACQUA acciaio inox 321L M/F / Stainless steel 321L WATER extensible joint M / F



Cod.	Size			€ / Cad.
VS0160050200	1/2"	100-200	18	7,80
VS0160050400	1/2"	200-400	18	8,85
VS0160050480	1/2"	260-480	18	10,90
VS0160070200	3/4"	100-200	18	10,67
VS0160070400	3/4"	200-400	18	13,57
VS0160070480	3/4"	260-480	18	15,41
VS0160507130	1/2" - 3/4"	75 - 130	18	9,35
VS0160507200	1/2" - 3/4"	100-200	18	9,90
VS0160507400	1/2" - 3/4"	200-400	18	11,30
VS0160507480	1/2" - 3/4"	260-480	18	13,26
VS0160100200	1"	100-200	18	15,74
VS0160100400	1"	200-400	18	20,27
VS0160100520	1"	260-520	18	22,92
VS0160120200	1" 1/4	100-200	18	29,36
VS0160120400	1" 1/4	200-400	18	35,27
VS0160120520	1" 1/4	260-520	18	41,52
VS0160150200	1" 1/2	100-200	18	35,91
VS0160150400	1" 1/2	200-400	18	44,35
VS0160150520	1" 1/2	260-520	18	50,05
VS0160200200	2"	100-200	18	50,26
VS0160200400	2"	200-400	18	55,97
VS0160200520	2"	260-520	18	63,36

clicca il seguente link: www.assotherm.it o scannerizza il QR-Code per scaricare le schede tecniche dei prodotti



NASTRO ANTICONDENSA

Nastro anticondensa in elastomero espanso / Anti-condensation tape in expanded elastomer



Cod.	Size	€ / pz.
VVOONASANTIC050310	30mm x 50mm x 10mt	8,01
VVOONASANTIC100310	30mm x 100mm x 10mt	15,55

NASTRO COPRIGIUNTO ALLUMINIO

Nastro coprigiunto tipo "Matak" / "Matak" type joint covering tape



Cod.	Size	€ / pz.
VVOONASAL100	100mm	25,30
VVOONASAL075	75mm	18,96

clicca il seguente link: www.assotherm.it o scannerizza il QR-Code
per scaricare le schede tecniche dei prodotti



Condizioni Generali

1. GENERALITA'

Le condizioni generali di vendita, qui di seguito riportate, si intendono valide per qualsiasi ordine pervenuto alla Assotherm srl e costituiscono parte essenziale di ciascun ordine. Eventuali modifiche alle presenti clausole nonché eventuali condizioni particolari dovranno essere espressamente concordate per iscritto.

2. ORDINI

Le ordinazioni acquisite dalla nostra rete di vendita sono soggette all'approvazione di Assotherm srl. Le ordinazioni devono rispettare i contenuti unitari riportati sul presente listino prezzi.

3. TRASPORTO

La merce viaggia a rischio e pericolo del committente il quale, nel proprio interesse, deve verificare, prima del ritiro, l'integrità dei colli e la quantità. Eventuali reclami dovranno essere avanzati alla Assotherm srl ovvero al vettore al momento della consegna.

4. CONSEGNE

La merce si intende resa Franco nostro magazzino. I termini di consegna hanno carattere indicativo e vengono concordati di volta in volta con il cliente.

5. PREZZI

Tutti i prezzi si intendono IVA Esclusa. Assotherm srl si riserva la facoltà insindacabile di apportare variazioni ai prezzi di listino pubblicati nel caso in cui le componenti di costo degli articoli lo rendessero necessario.

6. RESI

I resi di merce devono essere comunicati per iscritto entro 8 giorni dal ricevimento della merce. La merce verrà accreditata al prezzo di vendita decurtato del 25% per oneri di gestione della merce stessa, salvo controllo di integrità della merce stessa. I resi autorizzati dovranno essere inviati in porto franco direttamente al nostro magazzino.

7. PRODOTTI

Le fotografie contenute nel presente catalogo sono rappresentative del prodotto, a puro titolo esemplificativo. La Assotherm si riserva il diritto di apporre modifiche senza preavviso alcuno, in tutti i casi in cui si rendesse necessario.

8. PAGAMENTI

I pagamenti delle fatture devono essere indirizzati ad Assotherm srl secondo quanto pattuito e alla scadenza pattuita. Eventuali ritardi danno luogo all'immediata decorrenza degli interessi, nonché la sospensione automatica delle forniture.

9. PROPRIETA' DELLA MERCE

Il trasferimento della proprietà della merce avviene quando il cliente adempie alla propria prestazione attraverso il pagamento.

10. FORO

Per eventuali controversie è competente il Foro di Bergamo.



Born to be
partner!

 +39 035 813182

 info@assotherm.com

 www.assotherm.it

 Via F.lli Calvi, 7 - 24060,

Casazza (BG) - ITALIA