

IT ::	Collettore INOX per riscaldamento radiante
EN ::	Stainless steel manifold for radiant heating
FR ::	Collecteur en acier inoxydable pour chauffage radiant

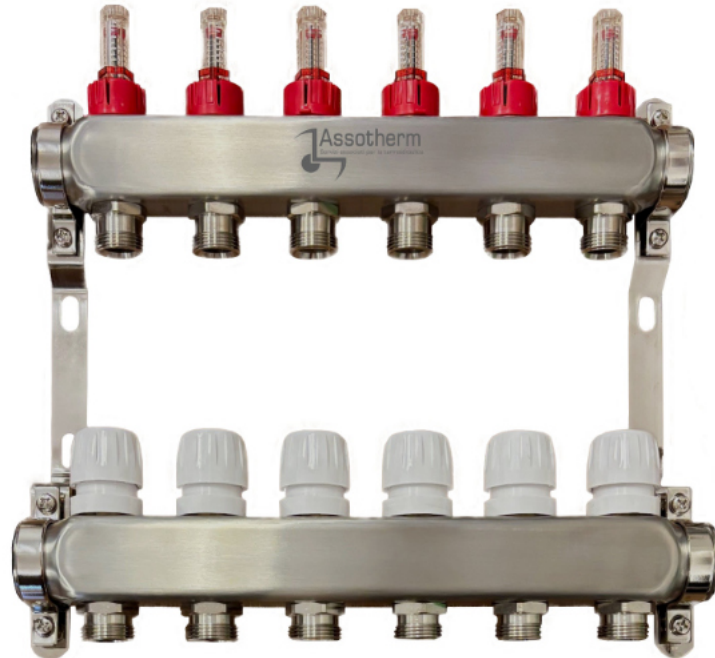

Collettore di distribuzione radiante da 3 a 13 vie
 1"-3/4"

 Caratteristiche

- Collettore in acciaio INOX AISI 304L stampato;
- Valvole di intercettazione predisposte per comando elettrotermico;
- Misuratori di portata;

Distribution manifolds heating floor from 3 to 13 ways
 1"-3/4"

 features

- Stainless steel AISI 304 L stamped distribution manifold;
- Shut-Off valves preset for electrothermal actuators;
- Flow meters;

Collecteur de distribution placher chauffant - 3 jusqu'à 13 voies 1"-3/4"

 fonctionnalités

- Collecteur de distribution matricé en acier INOX AISI 304 L ;
- Vannes d'arrêt prédisposées pour tête électrothermique ;
- Débitmètres;

 Dettagli Tecnici	
Corpo:	Acciaio INOX AISI 304L
Staffe:	Acciaio galvanizzato
Gruppo di carico:	Ottone stampato nichelato CW617N
Conessioni:	3/4" Eurokonus
Temperatura massima:	70°C
Pressione massima:	6 bar

 Technical Details	
Body:	Stainless steel AISI 304L
Mounting brackets:	Galvanized steel
Drain off and air vent:	Hot stamped brass CW617N nickel plated
Connection:	3/4" Eurokonus
Maximum temperature:	70°C
Maximum pressure:	6 bar

 Fiche Technique	
Corps:	Acier INOX AISI 304L
Supports:	Acier galvanisé
Raccord Air-vidange:	Laiton matriçé nickelé CW617N
Connexion:	3/4" Eurokonus
Température maximale:	70°C
Pression maximale:	6 bar

Dimensioni / Dimensions

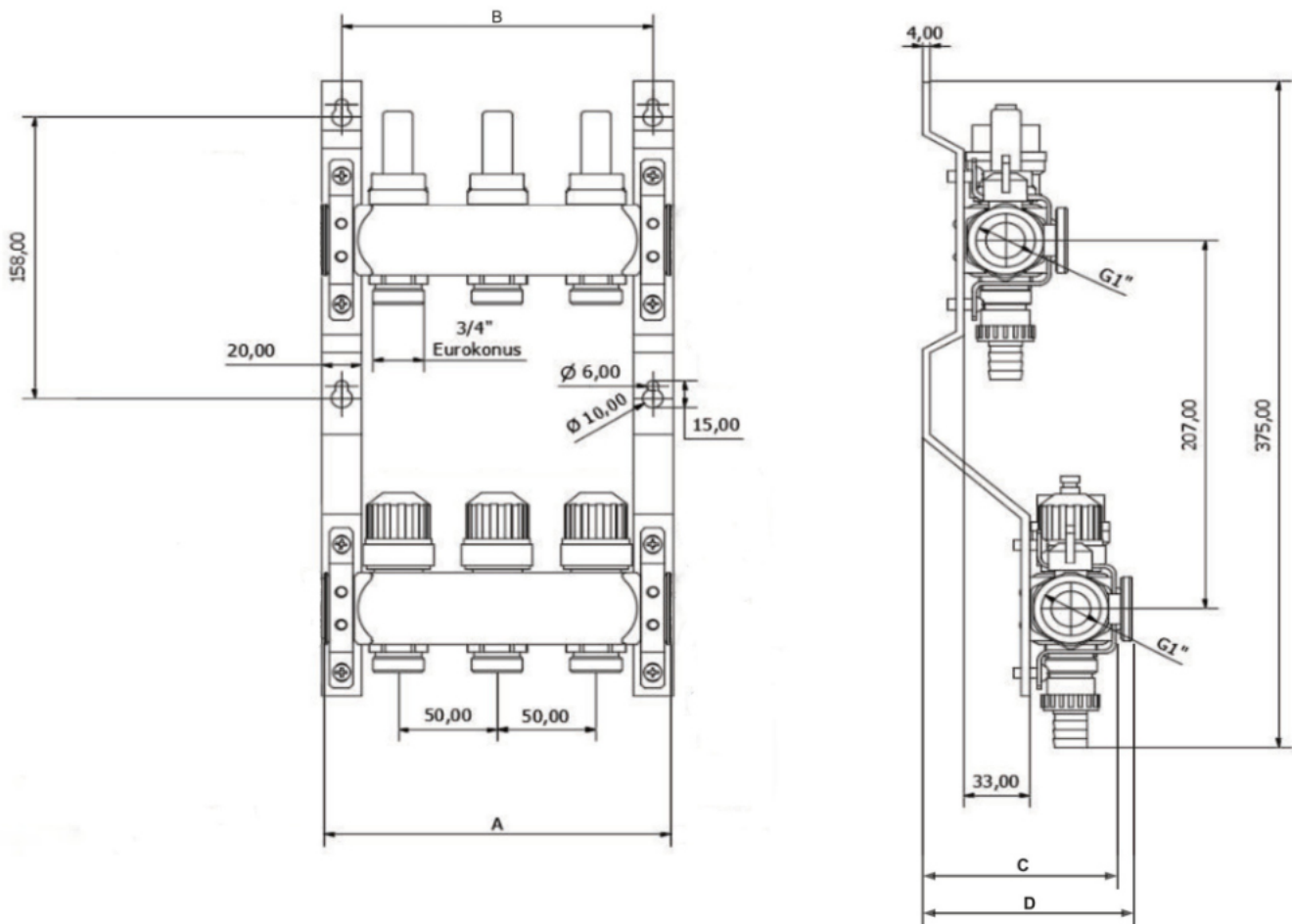

	3	4	5	6	7	8	9	10	11	12
A	175	225	275	325	375	425	475	525	575	625
B	164	214	264	314	364	414	464	514	564	614

	Staffe standard / Standard mounting brackets / Supports de montage standards	Staffe ribasste / Lowered brackets / Supports de montage abaissés
C	95	60
D	115	80

Dimensioni / Dimensions

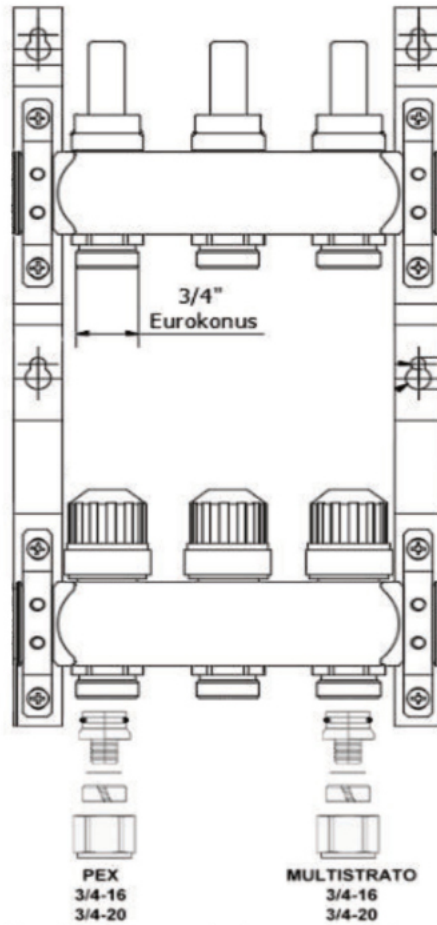

Diagrammi / Diagrams / Diagrammes

Diagramma con flussimetro tutto aperto
Diagram of flow meter fully open
Diagramme débitmètre totalment ouvert





Diagramma valvola di regolazione
Diagram Shut-Off valve
Diagramme de la vanne de réglage



Regolazione del flussimetro / Flow meter regulating / réglage du débitmètre

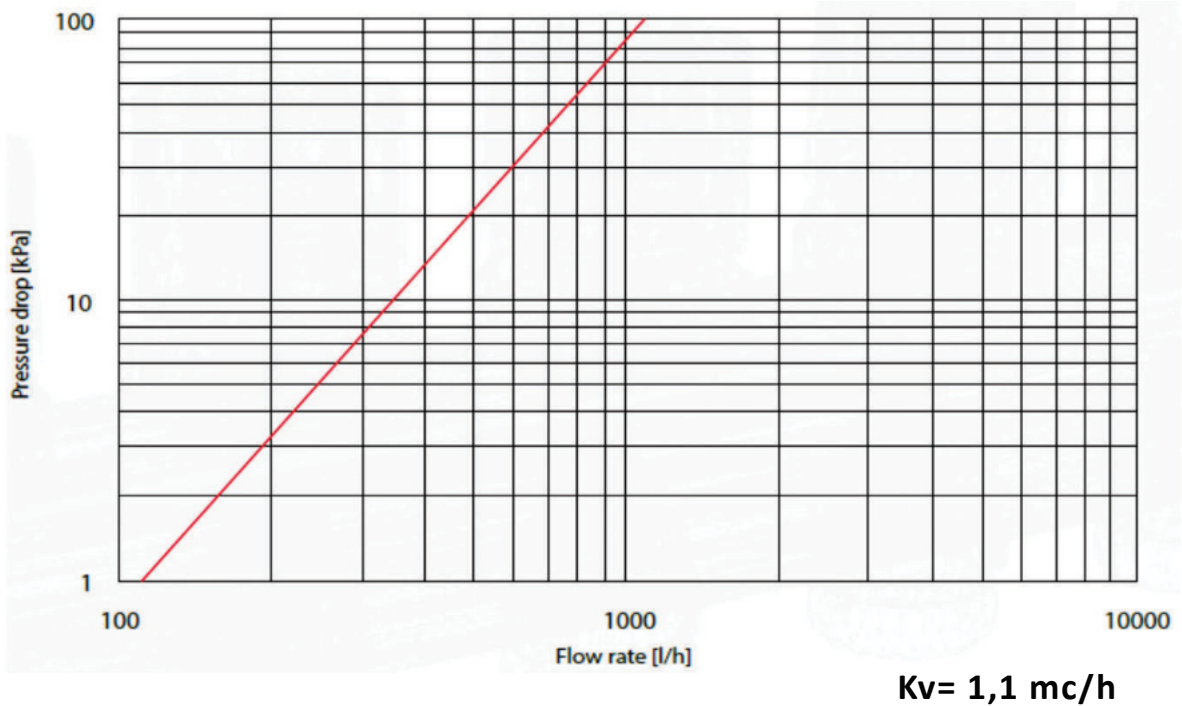
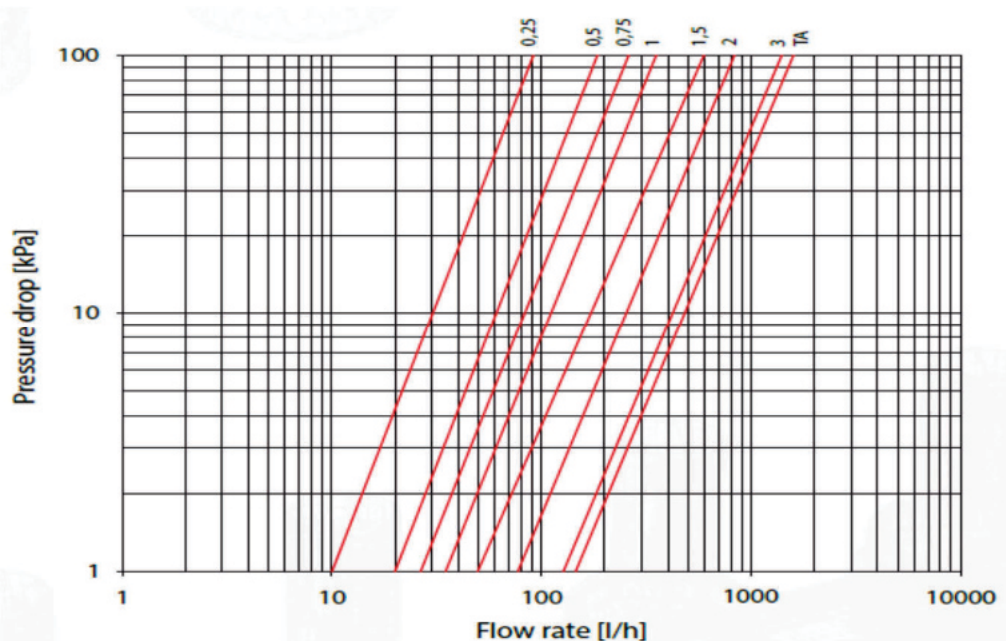
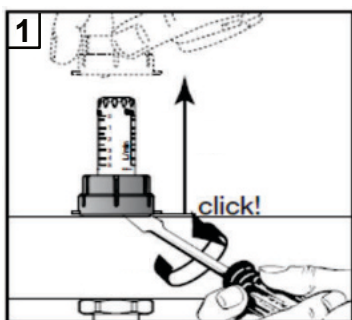



 Rimuovere il fermo a ghiera rosso in plastica, applicando la necessaria forza con un cacciavite, utilizzandolo come nell'immagine;

 Remove the red plastic ring retainer, applying the necessary force with a screwdriver, using it as in the image;

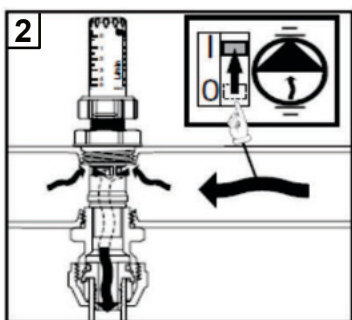
 Retirer l'anneau de retenue en plastique rouge, en appliquant la force nécessaire avec un tournevis, en l'utilisant comme sur l'image;





 Assicurarsi che la pompa che si occupa di mandare l'acqua nel collettore sia accesa, in modo tale da poter verificare in tempo reale l'esito della regolazione;

 Make sure that the pump that sends the water into the collector is turned on, so that you can check the outcome of the adjustment in real time;

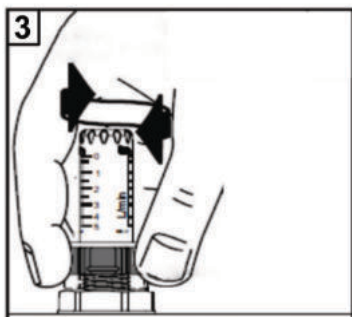
 Assurez-vous que la pompe qui envoie l'eau dans le collecteur soit allumée, afin de pouvoir vérifier le résultat du réglage en temps réel;



 Ruotare l'anello di regolazione in plastica nera in senso orario per ridurre il flusso nel circuito da regolare, viceversa, ruotarlo in senso antiorario per aumentarlo. Verificare la scala graduata indicante i L/min sul flussimetro. Attraverso questa regolazione, un anello rosso si posiziona sulla capacità desiderata.

 Rotate the black plastic adjustment ring clockwise to reduce the flow in the circuit has to be adjusted vice versa, rotate it counterclockwise to increase it. Check the graduated scale indicating L/min on the flow meter. Through this adjustment, a red ring is positioned on the desired capacity.

 Tournez la bague de réglage en plastique noir dans le sens des aiguilles d'une montre pour réduire le débit dans le circuit à régler, inversement, tournez-le dans le sens inverse des aiguilles d'une montre pour l'augmenter. Vérifiez l'échelle graduée indiquant L/min sur le débitmètre. Grâce à ce réglage, un anneau rouge se positionne sur la contenance souhaitée.