



Scheda Tecnica / Technical Details / Fiche Technique	
Cod. Art. CPS 0096B	
IT ::	Gruppo di carico / sfiato automatico per collettore CPS 856
EN ::	Drain off valve with automatic air discharge for CPS 856 manifold
FR ::	Unité de remplissage / purge automatique pour collecteur CPS 856



Cod.	
CPS00960110VB	Maniglia blu (ritorno) / Blue handle (return) / Poignée bleue (retour)

 Dettagli Tecnici	
Corpo:	Ottone stampato nichelato CW617N
Guarnizioni:	NBR

 Technical Details	
Body:	Hot stamped brass CW617N nickel plated
Gaskets:	NBR

 Fiche Technique	
Corps:	Laiton matriçé nickelé CW617N
Joints:	NBR

Dimensioni / Dimensions

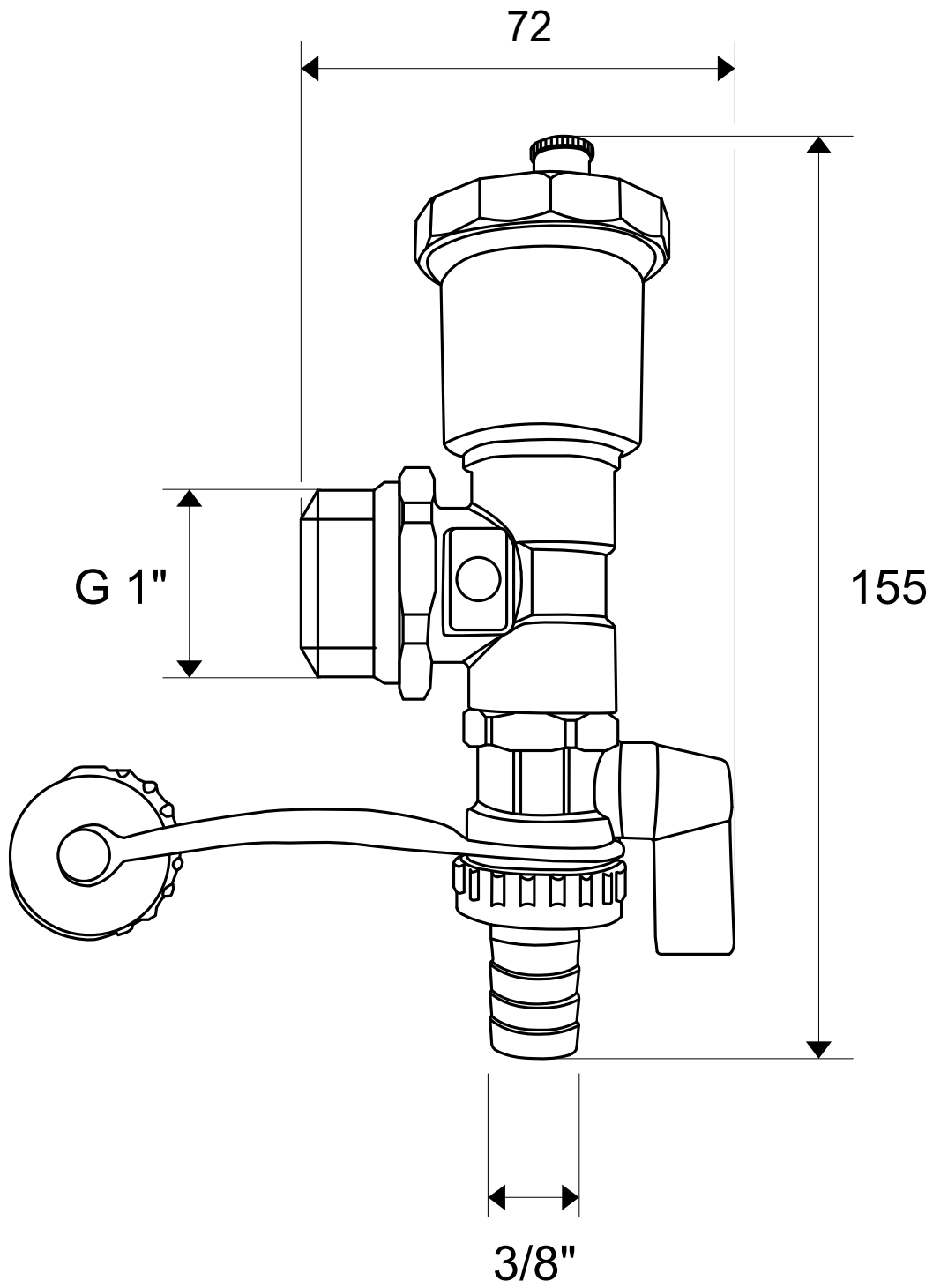

Istruzioni di montaggio kit di carico/sfiato - Drain off valve installation - instructions de montage vanne de remplissage/purge

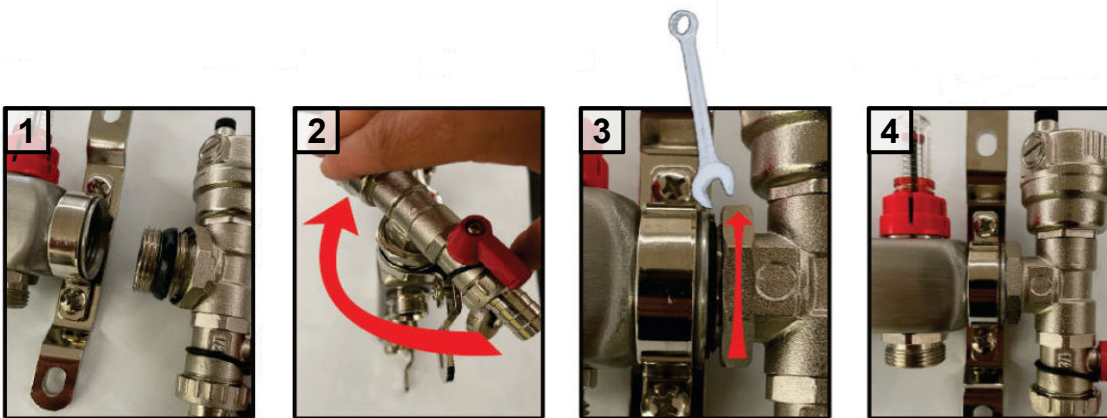

-  1. Inserire il kit di carico/sfiato nel collettore;
- 2. Avvitare a mano il kit di carico/sfiato fino a che la guarnizione sia a contatto con il collettore;
- 3. Serrare il kit di carico/sfiato avvalendosi di una chiave inglese, fino a portare la parte alta del kit (tappino di sfiato) verso l'alto;
- 4. posizione corretta.

-  1. Insert the drain valves kit into the manifold;
- 2. Screw the drain valves kit by hand until the rubber O-ring is in contact with the manifold;
- 3. Tighten the drain valves kit using a wrench, up to bring the upper part of the kit (vent cup) upwards
- 4. Correct position.

-  1. Insérez le kit de soupape d'échappement dans le collecteur ;
- 2. Vissez manuellement le kit de soupape d'échappement jusqu'à ce que le joint entre en contact avec le collecteur ;
- 3. Serrez le kit de soupape de décharge à l'aide d'une clé jusqu'à ce que le haut du kit (capuchon d'aération) soit orienté vers le haut ;
- 4. Position correcte.